



IN-CAB MONITOR AND  
SPRAYER CONTROLLER  
**Calibration**

RDS Part.No.:  
Doc. Issue:  
Software Issue:

S/DC/500-10-232  
2 :9/8/01  
PS519-000 rev.9

---

## Electromagnetic Compatibility (EMC)



This product complies with Council Directive 89/336/EEC when installed and used in accordance with the relevant instructions.

### **IMPORTANT, READ THIS BEFORE USING THE INSTRUMENT**

The installation is a part of the Precision Farming System ("the System"). It is very important that you follow the described calibration procedures before operating the instrument. Calibration and operation must be in accordance with these instructions. Use of the System is subject to the following disclaimer;

- 1. So far as is legally permissible RDS Technology ("RDS"), or its distributors, shall not be liable, whatever the cause, for any increased costs, loss of profits, business, contracts, income, or anticipate savings or for any special, indirect or inconsequential damage whatsoever (death or personal injury excluded).*
- 2. The capabilities and functions of the Precision Farming System ("the System") are limited as set out in the specification of the System, details of which are contained in the Help files and product literature and which must be read before using the System.*
- 3. Without prejudice to the generality of the above it is hereby acknowledged that the System is not designed nor intended to a) originate variable treatment plans or b) achieve or avoid any application rate outside application parameters, which in both cases shall be the responsibility of the operator.*
- 4. The standard terms and conditions of RDS (except clause 7), a copy of which is available on request, apply to the supply and operation of this System.*

## **Service and Technical Support**

PLEASE CONTACT:

Kellands Agricultural Spraying Supplies,  
Brimpsfield Rd.,  
Birdlip,  
Gloucester. GL4 8JH.

Tel 01452 863900  
Fax 01452 863400

Our policy is one of continuous improvement and the information in this document is subject to change without notice. Check that the software reference matches that displayed by the instrument.

© Copyright RDS Technology Ltd 2001

\UK232-2.DTP

# CONTENTS

<b>Section 1</b>	<b>Overview</b>			
1.1	The "Setup" Screen page . . . . .		5	
1.2	Data Entry . . . . .		6	
 <b>Section 2</b>	 <b>Sensor Configuration Menu</b>			
2.1	Forward Speed Sensor . . . . .		9	
2.1.1	Select Wheel Size - 9			
2.1.2	"Auto Cal" - 9			
2.1.3	Manual Calibration - 10			
2.2	Boom Configuration . . . . .		10	
2.2.1	Set Number of Boom Sections - 10			
2.2.2	Set Nozzles per Section and Nozzle Spacing - 11			
2.3	Flow / Pressure Sensor Setup . . . . .		12	
2.3.1	Channel - 12	} Configuration for Flow-based regulation		
2.3.2	Function - 12			
2.3.3	Sensed Width - 12			
2.3.4	Flow Sensor Cal Factor - 13			
2.3.5	Minimum and Maximum Flow - 13			
2.3.6	Start Delay - 13			
2.3.7	Valve Type - 13			
2.3.8	Channel - 14		} Configuration for Pressure-based regulation	
2.3.9	Function - 14			
2.3.10	Calibrate Pressure Sensor - 14			
<b>2.3.11</b>	<b>Changing the Regulation Mode - 15</b>			
2.4	Configuring the Control Valve . . . . .		16	
2.4.1	Channel - 16			
2.4.2	Response - 16			
2.4.3	Minimum Pulse - 16			
2.4.4	Deadband - 16			
2.4.5	Startup Delay - 16			
2.4.6	Control - 17			
2.5	Configuring a Tank Filling Sensor . . . . .		17	
2.5.1	Channel - 17			
2.5.2	Calibrating the Sensor - 17			
2.6	Alarms Setup . . . . .		18	
2.6.1	Max. Speed and Min. Speed - 18			
2.6.2	Max. Flow and Min. Flow - 18			
2.6.3	Off Target - 18			
2.7	Nozzle Setup . . . . .		19	
2.7.1	Editing the preset Nozzle Type- 19			
 <b>Section 3</b>	 <b>Flow Calibration</b>			
3.1	Initial Calibration - Using the "Jug Test Wizard" . . . . .		20	
3.2	Full-Tank Calibration. . . . .		22	

---

# CONTENTS

<b>Section 4</b>	<b>Technician Configuration Menu</b>	
4.1	Display Options.....	23
4.1.1	Speed Smoothing Factors - 23	
4.1.2	Rate Lock-On - 23	
4.1.3	Rate Smoothing - 23	
4.2	Control Options.....	24
4.2.1	Nudge Step Size - 24	
4.2.2	Off Target Alarm - 24	
4.2.3	Speed Related Options - 24	
4.3	Boom /Cutout Inputs.....	24
4.4	Print Calibration Data .....	25
4.5	Ports Setup - TOP Port .....	25
4.5.1	Enabling Printer Output - 26	
4.5.2	Connecting an RDS Data Module - 26	
4.5.3	Receiving VRT Instructions from other Control Systems - 26	
4.5.4	Direct Transfer of Field Data to a PC - 26	
4.6	Ports Setup - BOTTOM Port .....	26
4.6.1	Enabling GPS Output - 26	
4.6.2	Sending VRT Instructions to other Control Systems - 26	
4.7	Change PIN for Technician Menu .....	26
<b>Section 5</b>	<b>Factory Configuration Menu</b>	
5.1	Machine Options .....	27
5.1.1	TANK: Enable / Disable - 27	
5.1.2	TYPE: Type of Machine - 27	
5.1.3	NAME: Edit Tank Name - 27	
5.1.4	SPEED RELATED: Options - 27	
5.2	Total Software Reset .....	28
5.3	Backing Up and Restoring Calibration Data.....	28
5.4	Change PIN for Factory Configuration Menu.....	28
<b>Section 6</b>	<b>User Options</b>	
6.1	Set Time and Date.....	29
6.2	Adjust Screen Contrast and Brightness.....	29
6.3	Set Units.....	29
6.4	Select Language .....	30
6.5	Select Control Software .....	30
<b>Section 7</b>	<b>General PF Setup</b>	
7.1	Set Logging Interval.....	31
7.2	Edit Tag Names .....	31
7.3	Edit Function Names and Values.....	32
7.4	Set GPS Antenna Offset.....	32
7.5	GPS Home Location .....	33
7.5.1	Setting the Home Location - 33	
7.5.2	Moving to another location - 34	
<b>Section 8</b>	<b>AGRIBUGGY CAL Menu</b>	
8.1	Engine / Shaft RPM Sensor Cal Factor / Overspeed Alarms.....	35
8.2	Engine Hours Reset.....	35
8.3	Other ICM function settings.....	35

# 1 Overview

The instrument must be calibrated before commencing normal operation. Many settings are made only on initial installation e.g. from the 'SENSOR CONFIGURATION' screen. Other calibration settings may need to be altered on a regular basis according to the liquid being sprayed, nozzle types in use etc.

The "AGRIBUGGY CAL" menu has calibration settings for the ICM functions.

## 1.1 The "Setup" Screen page

Press the  key to select the SETUP menu (fig. 1).

**Figure 1**  
The information displayed on the SETUP screen

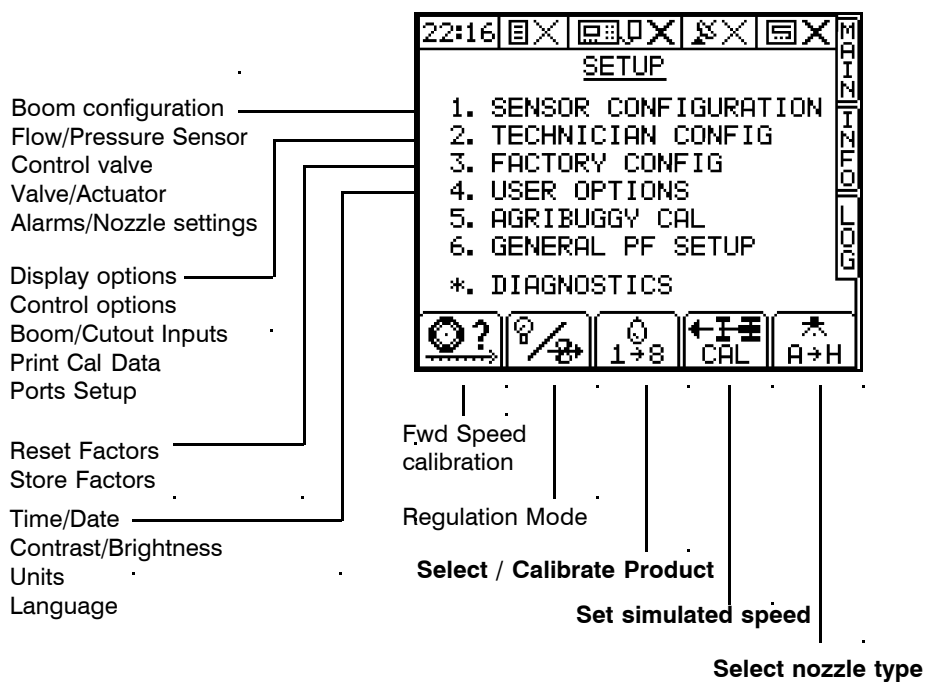

### Calibration on installation

Work through the 'SENSOR CONFIGURATION' menu first. Most of these settings need be done only once on installation.

Calibrate the ICM functions from the "AGRIBUGGY CAL" menu.

### Calibration in normal use

Calibration settings that need to be accessed more frequently are highlighted in bold type on figure 1. These settings include;

- Product calibration
- Tank and Product selection
- Nozzle type
- Speed alarm

## 1.2 Data Entry

Alpha-numeric values are entered via the right-hand keypad. You must press the key from 2 to 5 times to select the required letter. (Some keys also have additional special characters not shown on the key legend).

The  key will either toggle between lower and upper case characters or when preceding a numerical entry, will set a MINUS value.

The  key will toggle between 0 and a SPACE.

The  key will BACKSPACE the screen cursor if you need to re-enter a character.

The  key is the RETURN key and is normally pressed to confirm the data entry into memory.

# Calibration Menu - (Sprayers)

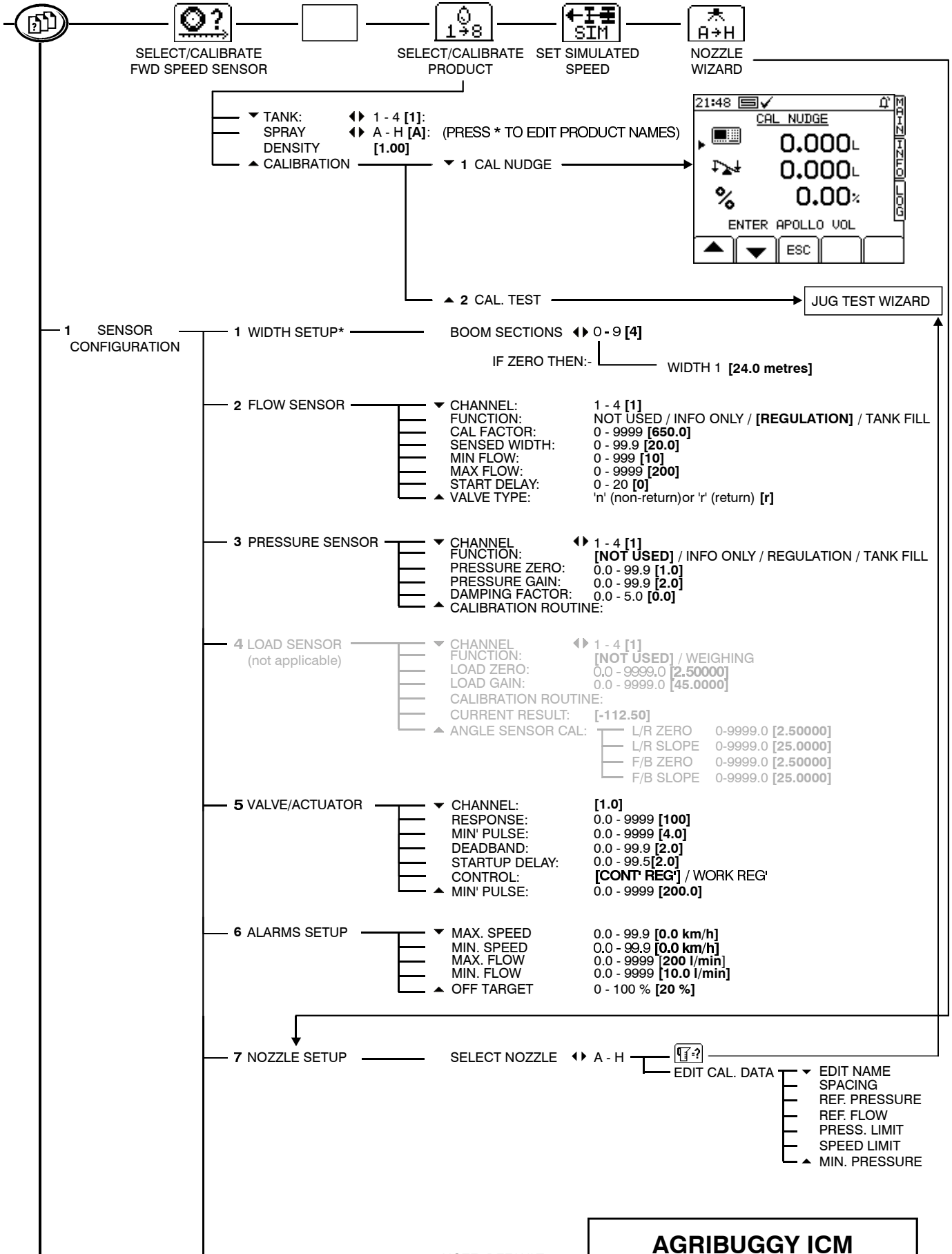

(MENU CONTINUED OVERLEAF)

NOTE: DEFAULT SETTINGS IN BRACKETS [ ]

## AGRIBUGGY ICM CALIBRATION MENU

SOFTWARE VERSION PS519-000 rev. 9

# Calibration Menu - (Sprayers)

FROM SETUP MENU

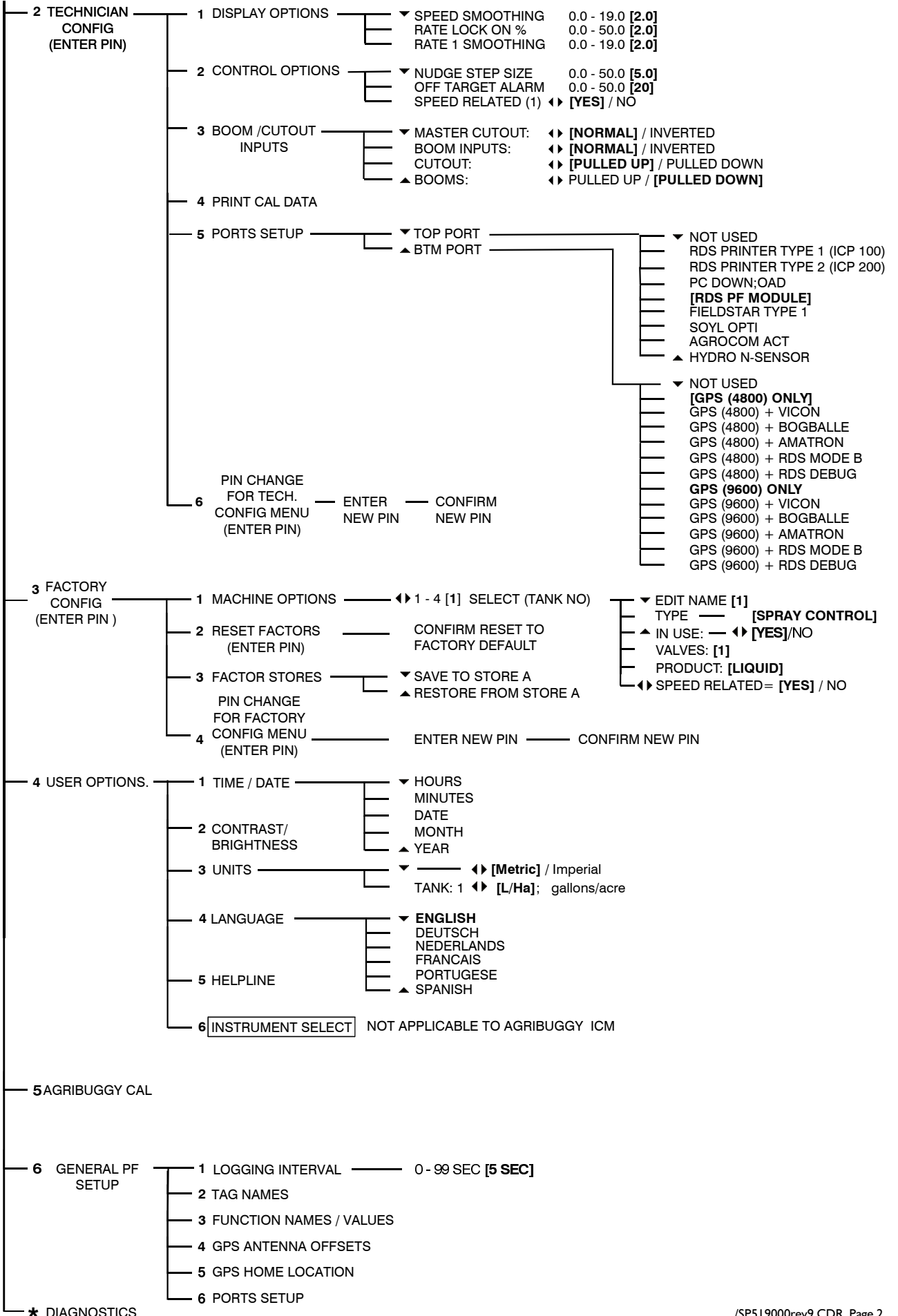

## 2 Sensor Configuration Menu

Calibrate the Forward Speed Sensor and Flow / Pressure Sensor before commencing liquid calibration.



### 2.1 Forward Speed Sensor



The Speed Sensor Factor ("SSF") is the distance travelled forward in the time between two pulses from the forward speed sensor. This could be calculated based on the nominal tyre diameter or rolling distance and then entered manually, however this does not take into account wheel slip, compaction, or tyre deformation under practical operating conditions. The best method is to do an "Auto Cal".

#### 2.1.1 Select Wheel Size (Wheel sensor fitted) / Radar Sensor

If the sprayer has a standard wheel sensor and magnets installed, you can programme the instrument with two speed sensor factors for flotation tyres and for row crop wheels. Remember to select the appropriate factor after changing wheels.

- 1 Press  to select the "SPEED FACTOR" screen (fig. 3).
- 2 Move the arrow cursor to select the factor appropriate for flotation tyre or row crop wheel size (or radar sensor if fitted), and press  to confirm.

**Figure 3**  
Selecting the wheel size  
/Radar Sensor

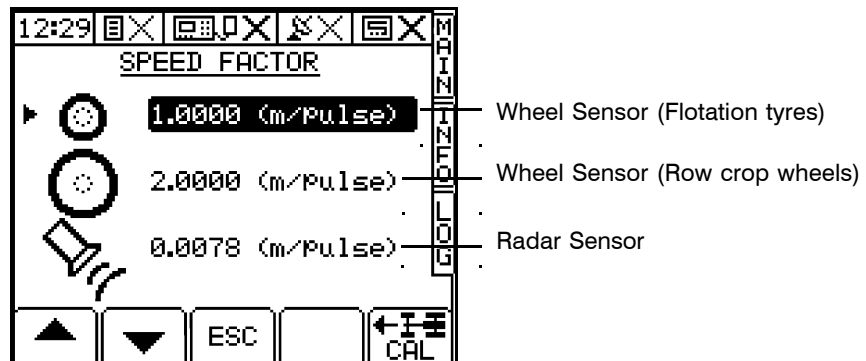

#### 2.1.2 "Auto Cal"

The "Auto Cal" procedure is the same for a wheel sensor or a Radar Sensor.

Mark a set distance of 100 metres (or 100 yards depending on the units set on the instrument) by suitable means. The surface should be representative of the average field conditions (i.e. not a paved surface). Position the vehicle with the first marker level with a suitable reference point on the vehicle.

With the appropriate setting highlighted on the "SPEED FACTOR" page, press ENTER, then select "Auto Cal". Press  and then follow the screen instructions.

Stop the vehicle when the second marker lies up with the pre-determined reference point on the vehicle and press  to end the "Auto Cal" procedure. The Speed Sensor Factor is automatically re-calculated and stored in memory.

**NOTE:** If you overrun the marker, do not simply reverse - repeat the "Auto Cal" procedure from the beginning.

**2.1.3 Manual Calibration**

If a two-magnet wheel sensor is fitted, drive in field conditions for exactly 10 turns of the sensed wheel.

If a propshaft sensor is fitted, drive in field conditions for exactly 20 turns of the propshaft.

In either case calculate the factor =  $\frac{\text{Distance travelled}}{10}$  and enter the value as follows;

With the appropriate sensor highlighted on the "SPEED FACTOR" page, press 

Key-in the new factor and press  to confirm the change.

If a an RDS Radar sensor is fitted (at the correct angle of  $37 \pm 1^\circ$ ),

- 1 Accept the default factor of 0.0078 metres/pulse.
- 2 Set the implement full width to 100m.

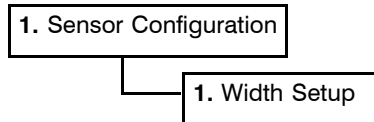

- 3 Select the "INFO" screen to display area accumulation and drive over a 100 metre measured distance. This must be a rolling 100 metres, not a start-stop 100 metres.

If the TGSS factor is correct, the AREA display will show 1.000 hectares. If not then adjust the factor based on the following calculation,

New factor = existing factor x displayed area (ha)

- 4 Go back to the "SPEED FACTOR" screen and enter the new factor (see above). Don't forget to reset the implement width to normal.

**2.2 Boom Configuration**

Select the "Width Setup" screen.

**Figure 4a**  
Setting the number of boom sections

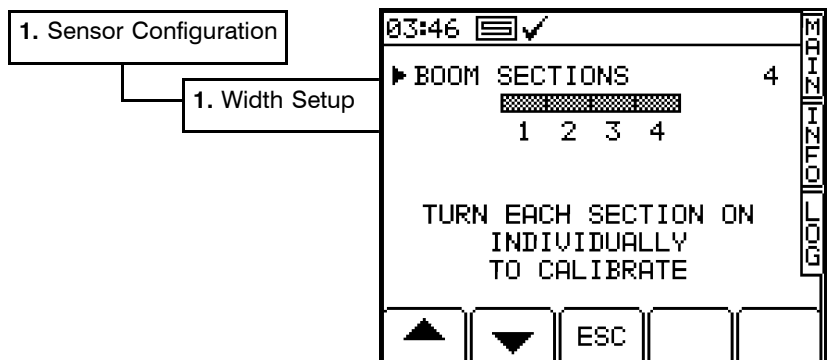

**2.2.1 Set number of Boom Sections**

Range: 0 - 9 Default: 4

With the screen cursor opposite "BOOM SECTIONS", enter the number of sections from 0 to 9 and press the ENTER button. When a boom section is switched on, the boom section block is filled in.

If boom sections are set to zero, then the whole boom is seen as one unit. The boom section inputs are ignored and the full spraying width is programmed.

**Figure 4b**  
Setting zero boom sections

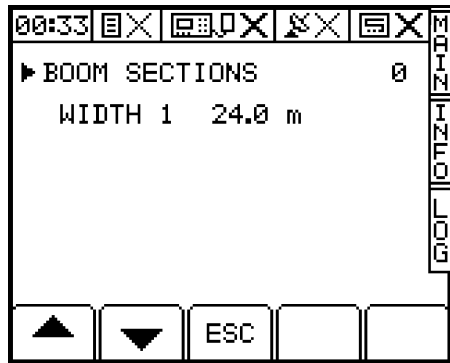

### 2.2.2 Set No. of Nozzles per section and Nozzle Spacing

This can also be set from the "Nozzle Wizard" screen page.

Switch on each section in turn and programme the number of nozzles and nozzle spacing for that section.

**Figure 5**  
Setting number of nozzles per section and nozzle spacing

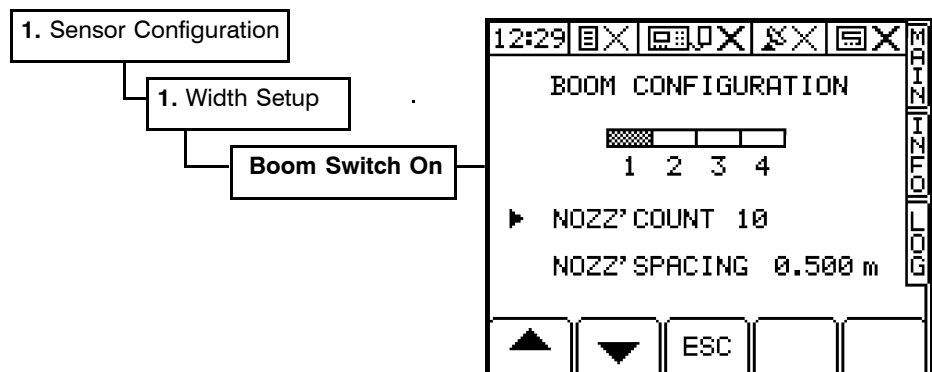

## 2.3 Flow / Pressure Sensor Setup

The sprayer control system can be installed with either a flow sensor, a pressure sensor, or both to enable either flow-based regulation or pressure-based regulation. **If the installation includes both a pressure sensor and a flow sensor you can re-configure the system at any time from the SETUP page for either type of regulation (section 2.3.11).**

In either case the one sensor is set for regulation and the second sensor is set either to provide information only (flow rate or pressure display), or can be disabled.

Do the Flow / Pressure Sensor Setup before doing the liquid calibration.

### Configure for Flow-based Regulation

**Figure 6**  
Flow Sensor Setup

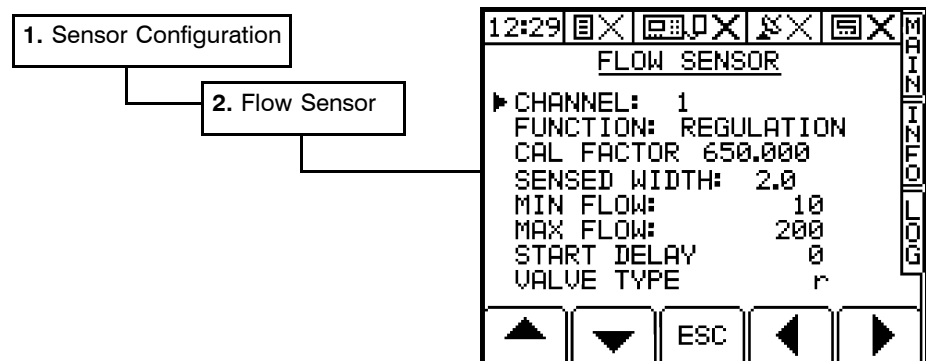

#### 2.3.1 Channel

Channel 1 is the default for single sprayer operation. Channel 2 is configured for a tank filling flow sensor.

*Default: Channel 1*

#### 2.3.2 Function

Select "REGULATION" for flow-based regulation. Select "NOT USED" if the system is being configured for pressure-based regulation (or "INFO ONLY" if you also want Flow Rate displayed when the system is configured for pressure-based regulation).

#### 2.3.3 Sensed Width

Programme the total width of the boom section(s) to which liquid is delivered *via the flow sensor*. This is normally the full boom width but in some installations, for practical reasons, it may be a single boom section.

*Default: 20.0 metres*

### 2.3.4 Flow Sensor Cal factor

Initially set the factor (pulses per litre or pulses per gallon) as given below, according to the size of turbine installed.

Turbine size	pulses/litre	pulses/Imperial gallon	pulses/US gallon
1/2"	3 700	-	-
3/4"	1 786	8 119	6 760
1"	650.0	2955	2 460
1-1/2"	1 650	7 491	6 245
2"	1 000	4 546	3 785

These values will be sufficient until you do a liquid calibration by means of a jug test.

**NOTE:** The Cal Factor will be automatically re-calculated and stored in memory after doing a flow calibration or nozzle calibration routine. It can otherwise be changed manually following "fine tuning" of the nozzle rate.

Default setting: 650 pulses/litre for a 1" turbine

### 2.3.5 Minimum flow and Maximum flow

Set the values according to the size of turbine fitted.

Turbine size	Min. flow (l / min)	Max. flow (l / min)
1/2"	3	30
3/4"	3	30
1"	10	1 00
1-1/4"	10	1 00
1-1/2"	35	3 50
2"	72	1 100

These values set the threshold for the "FLOW LOW" and "FLOW HIGH" alarms during operation. Minimum and maximum flow can also be set from the "ALARMS SETUP" screen. Set the maximum and minimum flow for the sensor in use.

Default: Min. flow = 10 l/min Max. flow = 200 l/min

### 2.3.6 Start Delay

When the whole boom or any boom section is switched on, there may be a rush of air or liquid as the boom line fills up which is not true flow out to ground. Flow accumulation will be ignored for this delay time (programmable from 0 - 20 seconds) after the boom is switched on. The flow should stop immediately the boom is switched off.

Default = 0 sec

### 2.3.7 Valve Type

(Flow-based sprayers only)

If each boom section valve when closed, simply shuts off the flow (e.g. solenoid valves), set to "N" for a non-recirculating system.

If each boom section valve when closed, diverts the flow back to tank (e.g. ARAG, Spray Systems valves), set to "R" for a re-circulating 'balanced return' system.

Default: "R"

**Configure for Pressure-based regulation**

**Figure 7**  
Pressure Sensor Setup

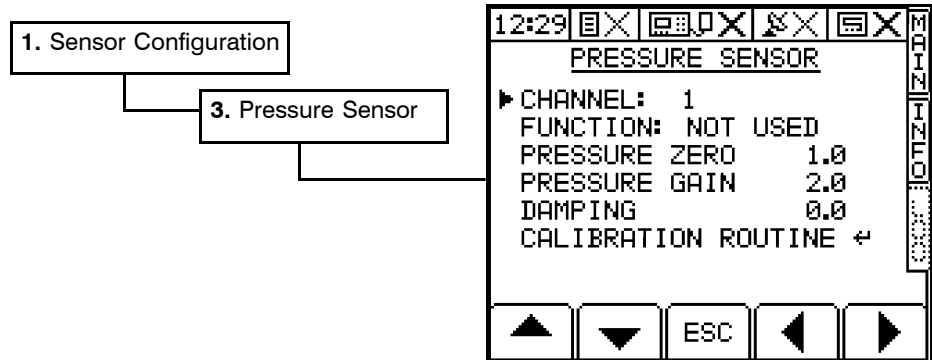

**2.3.8 Channel**

Channel 1 is the default for single sprayer operation. Channels 2- 4 are disabled.

**2.3.9 Function**





Select "REGULATION" for pressure-based regulation.

Select "NOT USED" if the system is being configured for flow-based regulation (or "INFO ONLY" if you also want pressure displayed when the system is configured for flow-based regulation).

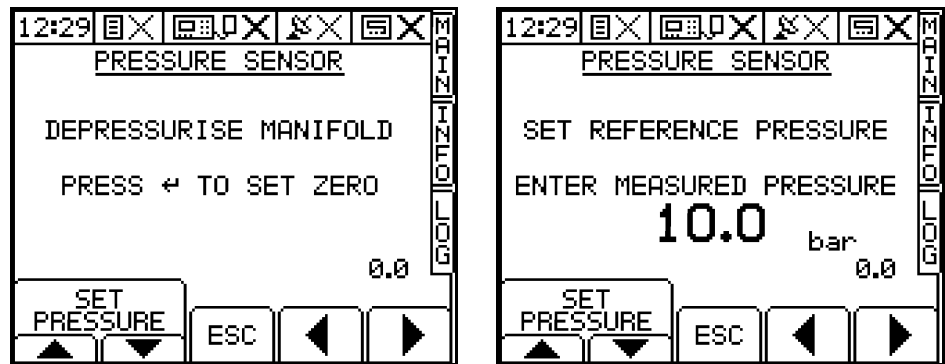
**2.3.10 Calibrate Pressure Sensor**

**Figure 8a and 8b**  
Calibrating the Pressure Sensor

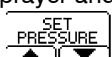

- 1 Select "CALIBRATION ROUTINE" (fig. 7) and press .
- 2 Depressurize the manifold and press  to set "PRESSURE ZERO".
- 3 Start the sprayer and set the reference pressure (the typical working pressure) using the  keys (fig. 8b).
- 4 Key-in the pressure indicated on the sprayer pressure gauge and press .

The "PRESSURE GAIN" is then set and is displayed on the "PRESSURE SENSOR" screen (fig. 7). The pressure sensor is now calibrated ready for nozzle calibration.

### 2.3.11 Changing Regulation Mode

On systems installed with both a flow sensor and a pressure sensor, you can very easily re-configure the system to enable either flow-based or pressure-based regulation.

On a flow-based system, high application rates (e.g. liquid fertiliser application) would require a large sized flow sensor to be installed. However this turbine may not be as accurate at lower application rates required for chemical applications. In this case it may be preferable to install a smaller flow sensor using flow-based regulation for lower application rates, and re-configure the system to use the pressure sensor for pressure-based regulation of high application rates.

- 1 From the SETUP screen, press the  button. (This only appears on the SETUP screen when both sensors are enabled).

**Figure 8c**

Switching between flow-based and pressure-based regulation

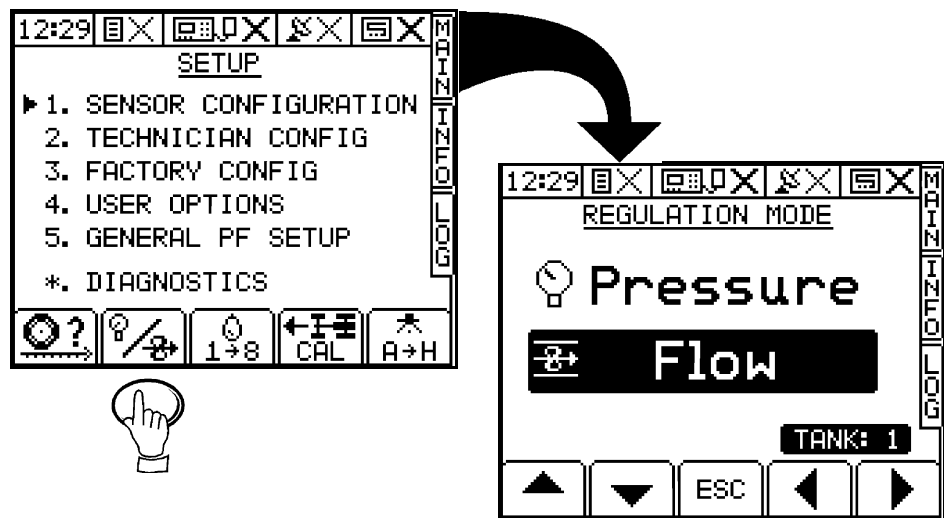

- 2 Select **Pressure** or **Flow** using the up / down arrow keys and press  to confirm.

If you have more than one "tank" in use, then select the tank number using the left / right arrow keys before selecting **Pressure** or **Flow**. Tank 1 is the default channel.

### 2.3.12 Damping

The damping factor enables fluctuations in the pressure readings to be smoothed out. By default the damping factor is zero.

## 2.4 Configuring the Control Valve

**Figure 9**  
Configuring the Control Valve

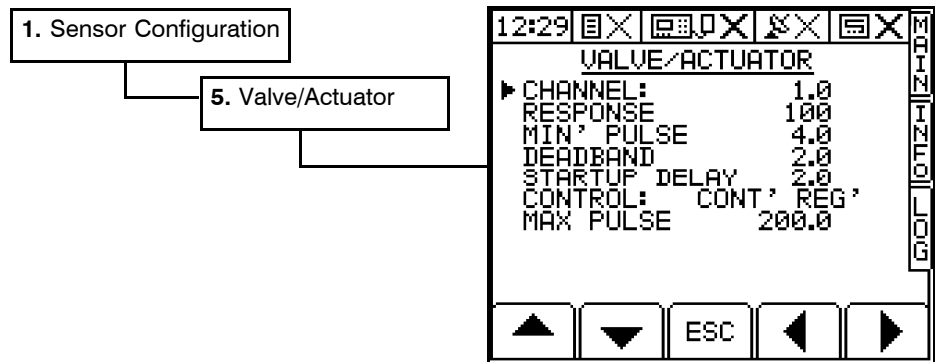

### 2.4.1 Channel

Channel 1 is the default for single sprayer operation. Channels 2 - 4 are disabled.

### 2.4.2 Response

The Response function sets the frequency at which the system adjusts the control valve when reacting to a change in forward speed. A lower setting results in a slower response, and increases the time taken for the application rate to match the target rate. A higher setting results in a faster response. If the application rate is unstable and varies about the target rate, then the response setting may be too high.

*Default: 100 Range: 0 - 9999*

### 2.4.3 Minimum Pulse

This sets the minimum pulse length (milliseconds x 4) driving the flow control valve. The pulses becomes shorter as the application rate nears the target rate. A lower setting gives shorter pulses - too short and the flow rate may not change sufficiently. If the pulse is too long, the system may be unstable about the target rate.

*Default: 4.0 (16 ms) Range: 0 - 9999*

### 2.4.4 Deadband

The Deadband function sets the range over which the flow rate will vary about the target rate before the control valve will respond. A lower value will make the control respond to a smaller variation in flow and vice versa. If the value is too low the system may be unstable about the target rate.

*Default: 2.0 Range: 0 - 99.9*

### 2.4.5 Startup Delay

If a spray boom is empty of liquid, the flow into it is rapid until it pressurises. The flow rate then reduces to the correct flow rate. Consequently the system takes some time to stabilise at the target rate. The instrument must be stopped from reacting to the initial flow surge.

Set the delay time to equal the time it takes for the sprayer system to reach normal working pressure. When the whole boom or individual section is switched on, the control valve will not operate for this time period.

*Default: 2.0 seconds Range: 0 - 99.5 seconds*

### 2.4.6 Control

"WORK REG" - Auto-regulation is only enabled when the boom is switched on.

The power supply to the control valve is switched off when switching off the boom. Therefore, when the sprayer is switched on at the beginning of the next bout, the control valve will be in the correct position enabling a faster return to the target rate.

"CONT' REG" - Auto-regulation is always enabled.

The control valve remains powered when the sprayer is switched off and will therefore close in response.

Default:: "CONT' REG"

### 2.4.7 Maximum Pulse

This sets the maximum pulse length (milliseconds x 4) driving the flow control valve. Do not change this value from the default of 200.0 (800 ms).

## 2.5 Configure a Tank-filling Sensor

Figure 10a  
Tank-Filling Sensor Setup

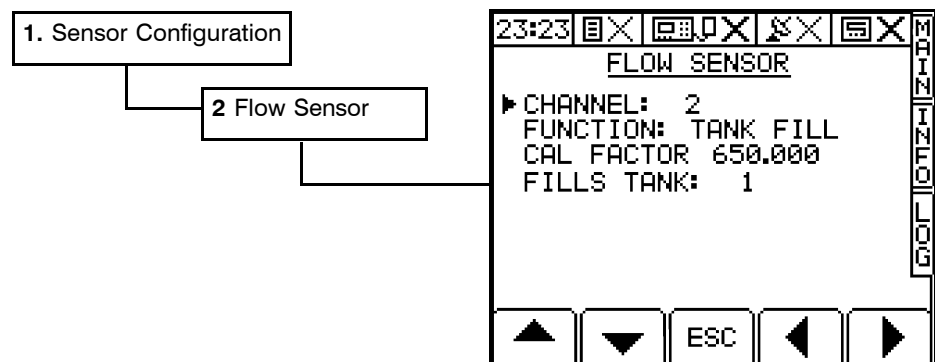

### 2.5.1 Channel

By default, channel 2 is configured for a tank-filling flow sensor.

### 2.5.2 Calibrating the Tank Filling Sensor

Initially set the calibration factor according to the size of turbine installed (2.3.1).

Default: 650 pulses/litre (for a 1" turbine).

Select the "INFO" screen and press  to access the TANK FILL screen.

Set the "NOW" volume to zero.

Fill the empty tank with the known volume (e.g. 2000 litres) of water via the inflow sensor and note the "NOW" volume displayed.

The correct Cal. factor =  $\text{Initial Factor} \times \frac{\text{"NOW" volume}}{\text{Actual volume}}$

e.g. Initial Cal. Factor = 100 and the "NOW" volume reads 1750 litres after filling 2000 litres;

New Cal. Factor =  $100 \times (1750/2000) = 87.5$

Go back to the "FLOW SENSOR" screen, key-in the new Cal. Factor and press .

## 2.6 Alarms Setup

There are a number of alarm conditions that are programmed in to the instrument. Some of these relate to the nozzle/sprayer performance and are derived from the "Nozzle Wizard". Some are covered in other calibration menus e.g. for the ICM functions. All other alarms are setup from the ALARMS SETUP screen page (fig. 10b)

**Figure 10b**  
Alarms Setup

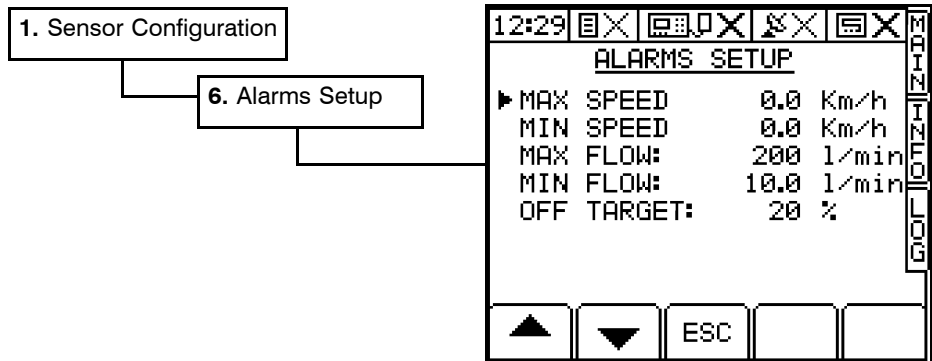

### 2.6.1 MAX. SPEED and MIN. SPEED

These values set the thresholds for the forward speed alarms. They are automatically set according to the Target Speed in the "Nozzle Wizard", however, you can manually key-in another value via the alpha-numeric keypad.

When another nozzle type is selected in the "Nozzle Wizard", any manually programmed thresholds will be overwritten by the "Nozzle Wizard".

*Default = 0 (Alarms Off)*

### 2.6.2 MAX. FLOW and MIN. FLOW (Flow-based regulation only)

These values set the thresholds for the "FLOW HIGH" and "FLOW LOW" alarms during operation. Minimum and maximum flow can also be set from the "FLOW SENSOR" screen. Set the values according to the size of turbine fitted (ref. section 2.3.1).

*Default: Min. flow = 10 l/min                      Max. flow = 200 l/min*

### 2.6.3 OFF TARGET

This sets the threshold at which the instrument will alarm "UNDER APPLICATION" or "OVER APPLICATION" when spraying in automatic control mode. It is set as a percentage either side of the current target rate.

*NOTE: This can also be set from the "CONTROL OPTIONS" page.*

*Default = ± 20%*



## 2.7 Nozzle Setup

**Figure 11**

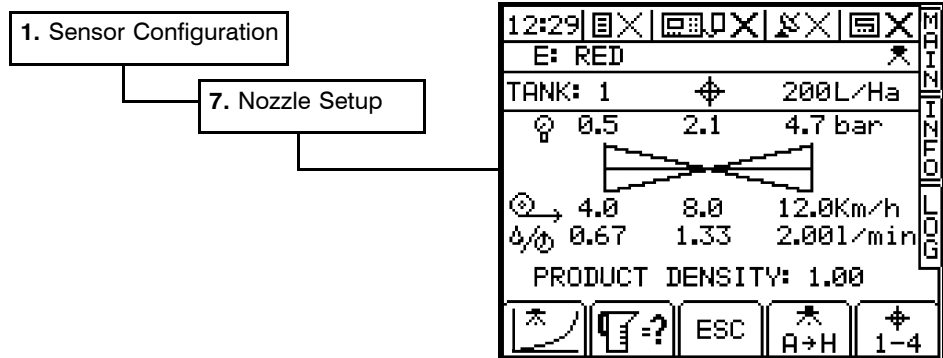
The Nozzle Setup screen otherwise called the "Nozzle Wizard"



**NOTE:** The Nozzle Setup screen (the "Nozzle Wizard") is also accessed by pressing the  key directly from the "SETUP" screen. The instrument is pre-programmed with nozzle data for 8 ISO standard nozzle types.

Press  to select a nozzle type. Press repeatedly to cycle through nozzle types A to H. Press  to confirm the nozzle selection.

Press  to start the nozzle calibration procedure (see section 3).

### 2.7.1 Editing the preset Nozzle type

If the nozzles fitted do not correspond to any of the 8 preset types, then you can easily edit the data for any of the nozzle types A to H.

Press  to select the "NOZZLE EDIT" screen (fig. 12). For all parameters, move the cursor to the appropriate line and enter the new data via the alpha-numeric keypad.

**Figure 12**

Editing preset nozzle data



# 3 Flow Calibration

Ensure the Flow / Pressure sensors have been properly configured (section 2) before doing a liquid calibration. When spraying denser liquids such as liquid fertilisers, ensure beforehand that you have selected the correct product and have programmed the correct density for that product, from the "PRODUCT CALIBRATION" screen.

## 3.1 Initial Calibration - using the "Jug Test Wizard"

The following procedure applies for both pressure-based and flow-based regulation. Carry out initial calibration using clean water.



- 1 Set the simulation speed to match the desired speed during spraying, and set the target rate to equal the desired application rate. Target speed can be set from the "Nozzle Wizard" or from the main screen.
- 2 Select the most suitable nozzles from the nozzle wizard (section 2.3 in the operation manual).
- 3 Press  to start the calibration routine. The calibration speed is then displayed (fig. 13b).
- 4 Change the the calibration speed if necessary, from that displayed and press  to accept. The "CAL TEST" screen is then displayed. It flashes "CAL" to indicate that speed is being simulated, and gives the message "TURN ON NOW".
- 5 Switch the sprayer on with the jug under the appropriate nozzle. When a boom section is switched on, the "CAL TEST" screen then displays pressure (fig 13c).

Figure 13b and 13c  
Nozzle calibration routine



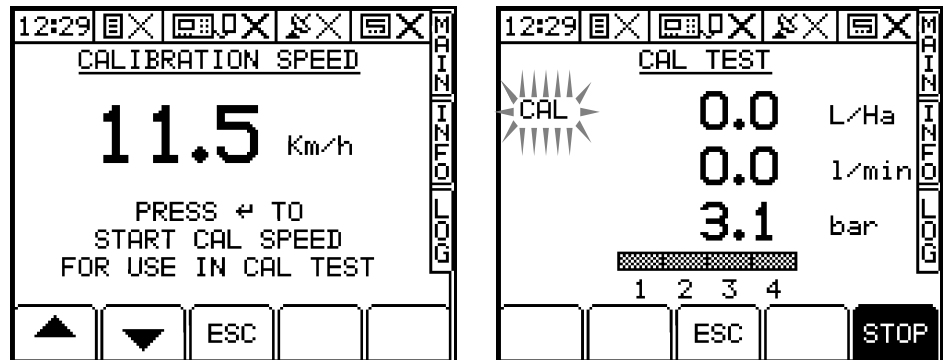

- 6 Press the STOP key to end the metering period.
- 7 Enter the test time (default = 60 sec) and press .
- 8 Enter the test volume (or averaged test volume) and press .

Figure 14  
Enter jug test measurements



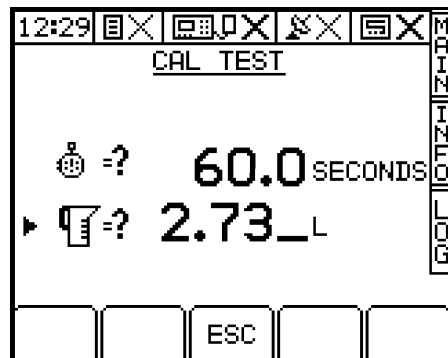

The instrument then calculates and displays the new calibration factors (fig. 15). Since you can have both a flow sensor and pressure sensor enabled (one sensor for regulation and one for feedback - "INFO ONLY") you will see both:-

- NOZZLE FLOW RATE in litres/min/nozzle ("REF FLOW" on the nozzle data page) for pressure-based regulation.
- FLOW SENSOR CALIBRATION FACTOR in pulses per litre for flow-based regulation.

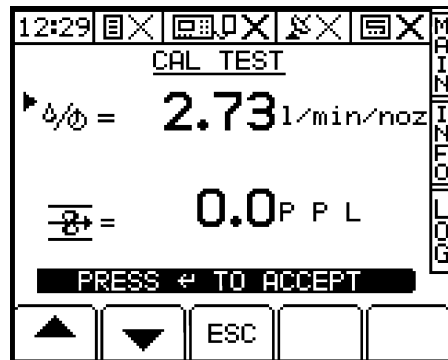
**Figure 15**  
Flow calibration factors



**NOTE:** *It is advisable to repeat the jug test for several nozzles across the boom and enter the average of the individual test volumes.*

- 9 Press  to accept the nozzle flow rate, (or first enter a revised figure e.g. the averaged flow rate over a number of jug tests).
- 10 Press  to accept the flow sensor calibration factor (or first enter a revised figure).



**If you don't want to accept the calculated result, press ESC to go back through the previous screens.**

**NOTE:** *Performing the jug test changes the previous nozzle flow rate ("REF FLOW") figure stored in the "Nozzle Wizard", and will also correct the calibration factor for the flow turbine.*

*The jug test is not the most accurate method of calibration particularly for the flow turbine on flow-regulated systems, as the test volume is relatively small. It is therefore recommended to subsequently perform a full-tank calibration, spraying a tankful out in the field.*





### 3.2 Full-Tank Calibration

The calibration figure should be subsequently "fine-tuned" after spraying out a full tank in the field. **Be certain of the the volume sprayed out since the sprayer sight gauge may not be accurate enough for calibration purposes.** The liquid calibration should be checked and adjusted regularly over the season to compensate for factors including nozzle wear.

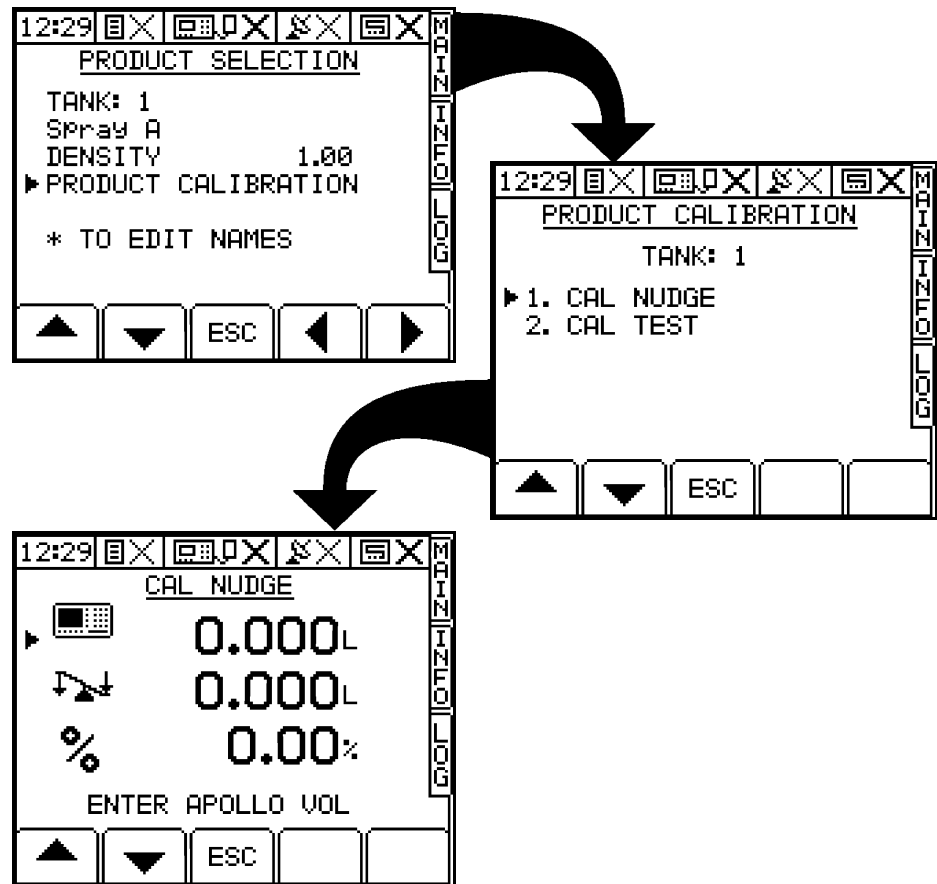
- 1 From the SETUP page press  to select the "PRODUCT SELECTION" page.
- 2 If you are spraying clean water or chemicals, check that the product (default name = "Spray A") has density set to 1.00. If spraying liquid fertiliser, check the product and density is selected and programmed.
- 3 Select the "INFO" screen and reset the "PART TOTAL" to zero.
- 4 Spray out the whole tank then select the "INFO" screen and note the "PART TOTAL" clocked.
- 5 Compare this with the known volume sprayed out. If there is a difference between the two figures, then correct the error via the CAL NUDGE screen as follows:
- 6 Go back to the "PRODUCT SELECTION" page, select "PRODUCT CALIBRATION" and press  (fig. 16).
- 7 Select "CAL NUDGE" and press  (fig. 16) .

**Figure 16**  
Nudging the calibration factors



- 8 Enter the instrument total  and press , then the known volume sprayed out  and press . Finally, press  again to confirm the nudge.

The calibration factors are then adjusted accordingly.

## 4 Technician Configuration Menu

The operator is unlikely to need access in normal use. Access to this menu can be restricted by changing the PIN number from within the menu.

Enter the default PIN number 1234 to access the menu.

### 4.1 Display Options

Figure 17  
"Display Options" page

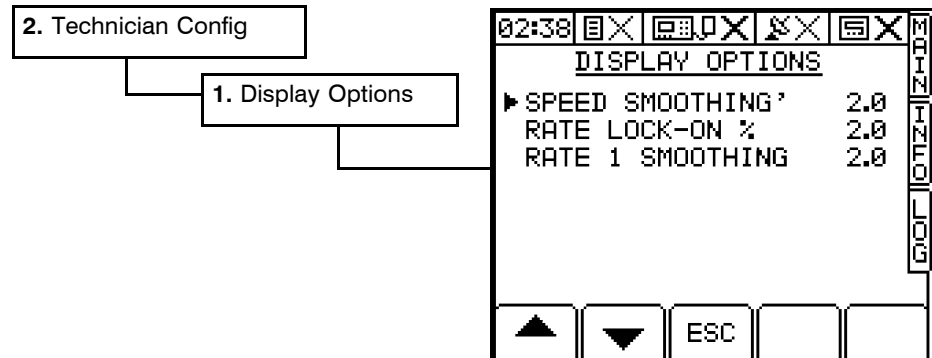

#### 4.1.1 Speed Smoothing Factor

The Forward Speed display is electronically damped. If the readouts are constantly changing by small increments, you can increase the damping time to give a steadier readout.

*Adjustable from 0 to 19 seconds. Default = 2 seconds*

#### 4.1.2 Rate Lock-On

"RATE LOCK-ON" sets the % by which the application rate fluctuates either side of a nominal application rate *before* the instrument display changes.

For example, if your actual application rate fluctuates in normal operation from 97 to 103 l/ha for a target application rate of 100 l/ha, you may decide that it is acceptable for the instrument to display a steady readout of 100 l/ha between those limits i.e.  $\pm 3\%$ . In this case the rate lock-on figure should be set to 3.0.

*Adjustable from 0 to 50% Default = 2%*

#### 4.1.3 Rate Smoothing

The Application rate display is electronically damped. If the readouts are constantly changing by small increments, you can increase the damping time to give a steadier readout.

*Adjustable from 0 to 19 seconds. Default = 2 seconds*

## 4.2 Control Options

**Figure 18**  
"Control Options" page

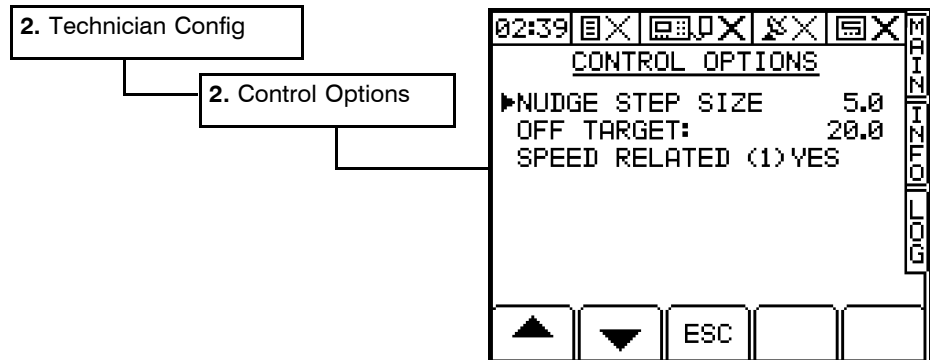

### 4.2.1 Nudge Step Size

The Nudge Step Size sets the % increase / decrease made when you adjust from the target rate in AUTO mode.

*Adjustable from 0 to 50% Default = 5%*

### 4.2.2 Off Target Alarm

This sets the threshold at which the instrument will alarm "UNDER APPLICATION" or "OVER APPLICATION" when spraying in automatic control mode. It is set as a percentage either side of the current target rate.

*NOTE: This can also be set from the "ALARMS SETUP" page.*

*Adjustable from 0 to 50% Default = 20%*

### 4.2.3 SPEED RELATED: Options

Default = "YES" - This enables the flow rate to be automatically adjusted according to the forward speed, to match the target application rate (l/ha) in AUTO mode.

"NO" - The target application rate (l/ha) is replaced by the target flow rate (l/min). The control system will then seek to achieve this target rate.

*NOTE: This is also configurable from the "MACHINE OPTIONS" page.*

## 4.3 Boom Cutouts / Inputs

**Figure 19**  
"Boom/Cutouts Inputs" page

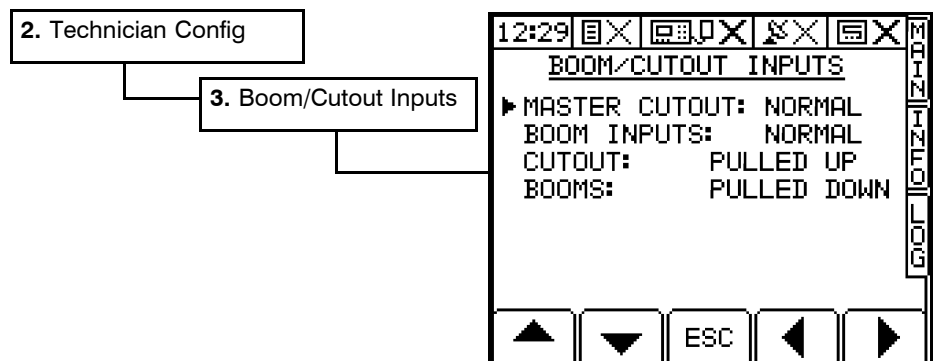

**Master Cutout**

**NORMAL:** The sprayer is ON when the cutout input is NOT recognised.  
**INVERTED:** The sprayer is ON when the cutout input is recognised.

**Boom Inputs**

**NORMAL:** The boom section is ON when the boom section input is recognised.  
**INVERTED:** The boom section is OFF when the boom section input is recognised.

**Cutout**

**PULLED UP;** Master cutout input is recognised when it closes to 0V.  
**PULLED DOWN:** Master cutout input is recognised when it closes to +V.

**Booms**

**PULLED UP;** Boom section input is recognised when it closes to 0V.  
**PULLED DOWN:** Boom section input is recognised when it closes to +V.

Default settings shown in bold. Change as required using the arrow keys.

**4.4 Print Calibration Data**

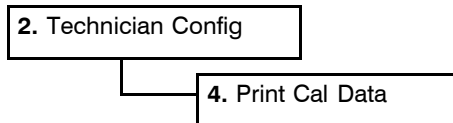

It is always a good idea to keep a record of calibration data either in the back of the manual, or as a printout. Connect the printer to the upper serial port. Ensure first that the port has been configured for a printer (section 4.5.1).

Selecting the "PRINT CAL DATA" menu function immediately sends the data to the serial port. The message "**Printer Busy**" is displayed while data transfer is occurring.

If the bar on the screen stops filling up part way, the instrument cannot communicate with the printer. Check the connections.

**4.5 Ports Setup - Top Port**

**4.5.1 Enabling Printer Output**

Set the top port to "RDS PRINTER TYPE I" for an RDS ICP 100 printer, or "RDS PRINTER TYPE II" for an RDS ICP 200 printer. The data protocol is:

	Printer Type I	Printer Type II
Baud rate:	4 800	4 800
Data Bits:	7	8
Stop Bits:	2	1
Parity:	None	None
Handshake:	Hardware	Hardware

These settings cannot be changed. If you are connecting a different printer, it must conform to either of these protocols.

**4.5.2 Connecting an RDS Data Module**

Set the top port to "RDS PF MODULE".

**4.5.3 Receiving Variable Rate Treatment instructions from other control systems**

The instrument can act on variable-rate treatment instructions received from another controller. Presently it can receive instructions from FIELDSTAR (TYPE 1), SOYL OPTI, AGROCOM ACT and HYDRO-N SENSOR instruments.

Set the top port as appropriate.

**4.5.4 Direct Transfer of Field Data to a PC**

If you are connecting a PC using an RDS Download Lead in order to transfer ordinary field data and job memos, set the top port to "PC DOWNLOAD".

**4.6 Ports Setup - Bottom Port**

**4.6.1 Enabling GPS Input**

If the instrument is installed with an RDS control system, then set the bottom port to either "GPS (4800) ONLY" or "GPS (9600) ONLY" , according to the baud rate that your GPS receiver has been configured.

**4.6.2 Sending Variable Rate Treatment instructions to other control systems**

The instrument can also output variable-rate instructions to other control systems other than an RDS control system. Currently it can send instructions to Vicon, Bogballe and Amatron systems.

Set the bottom port to the appropriate baud rate/control system option from the menu:

- GPS (4800) + VICON
- GPS (9600) + VICON
- GPS (4800) + BOGBALLE
- GPS (9600) + BOGBALLE
- GPS (4800) + AMATRON
- GPS (9600) + AMATRON

**NOTE:** Ignore "RDS MODE B" and "RDS DEBUG" options.

**4.7 Change PIN for Technician Menu**

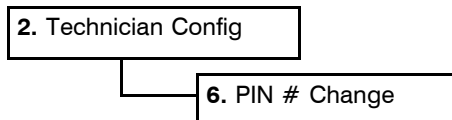

You can re-programme your own PIN for this menu. Just follow the screen instructions.

If you forget your personalised PIN, you will need to contact RDS for instructions.

# 5 Factory Configuration Menu

The operator is unlikely to need access in normal use. Access to this menu can be restricted by changing the PIN number from within the menu.

Enter the default PIN number 1234 to access the menu.

## 5.1 Machine Options



The "MACHINE OPTIONS" screen normally enabled you to configure each of up to 4 control channels, however, only channel 1 is enabled on the Agribuggy™ instrument.

**Figure 20**  
Selecting the "Machine Options"

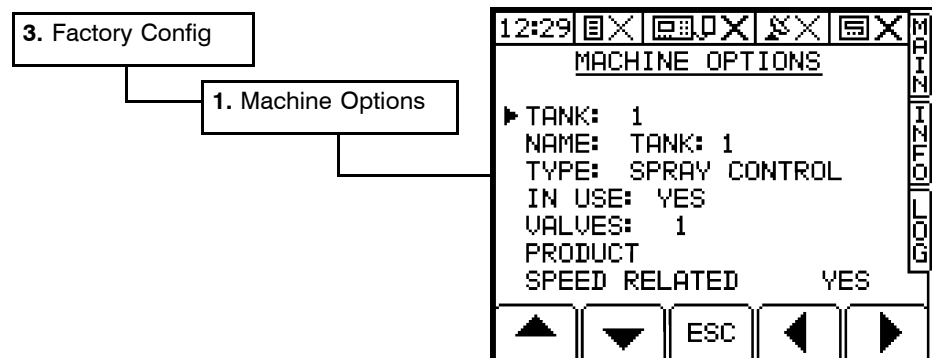

### 5.1.1 TANK: Enable / Disable "Tanks"

Selects Tank 1 to 4. Using the arrow keys, move to the "IN USE" line and select "YES" or "NO". By default, only Tank 1 is enabled.

### 5.1.2 TYPE: Type of machine

Preset to "SPRAY CONTROL".

### 5.1.3 NAME: Edit Tank Name

You can edit the default name ("Tank #"). The maximum length is 20 characters.

### 5.1.4 SPEED RELATED: Options

Default = "YES" - This enables the flow rate to be automatically adjusted according to the forward speed, to match the target application rate (l/ha) in AUTO mode.

"NO" - The target application rate (l/ha) is replaced by the target flow rate (l/min). The control system will then seek to achieve this target rate.

**NOTE:** This is also configurable from the "CONTROL OPTIONS" page.

## 5.2 Total Software Reset

**Figure 21**  
Resetting the calibration factors to the factory default values

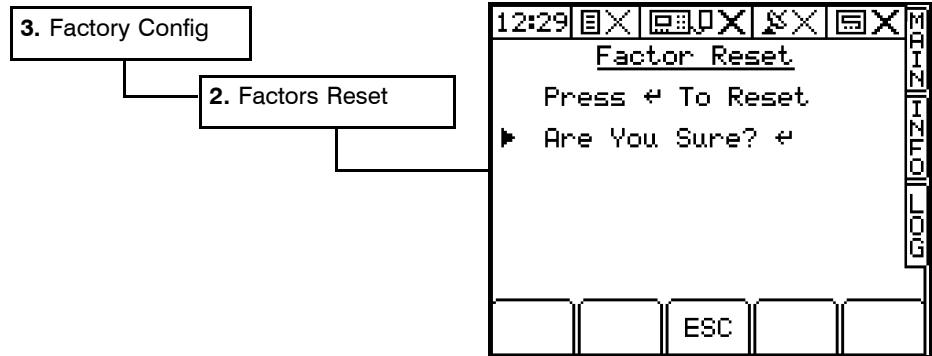

A "FACTOR RESET" should be considered in two instances. Firstly, if the instrument is to be transferred to a different sprayer, it may be easier to re-calibrate the instrument from the factory default settings in a systematic way. Secondly, if you are encountering problems with the instrument during operation but cannot successfully resolve them, a total software reset may help in the troubleshooting procedure.

Follow the screen prompts to reset the instrument to the factory default settings.

**NOTE:** *All customised factors and other data will be lost. It is recommended you keep a record of the existing calibration data.*

## 5.3 Backing Up and Restoring Calibration Data

For extra security, calibration data can be manually saved to a separate memory area called "STORE A". This data will NOT be overwritten each time the instrument is switched off, but it WILL be cleared after a Total Software Reset ("RESET FACTORS").

If for example, any calibration data is unwittingly changed without keeping a record of previous settings or data is corrupted, you can restore the calibration data from "STORE A" at any time.

**Figure 22**  
Save / Restore CAL Data

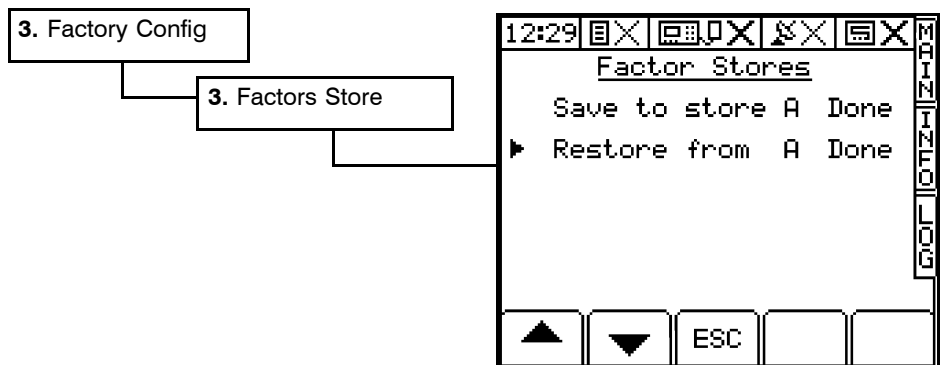

## 5.4 Change PIN for Factory Configuration Menu

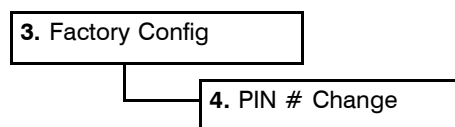

You can re-programme your own PIN for this menu. Just follow the screen instructions. If you forget your personalised PIN, you will need to contact RDS for instructions.

## 6 User Options

### 6.1 Set Time and Date

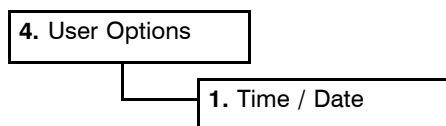

If you need to change the time or date setting, position the cursor against the relevant line, key-in the new value and press .

### 6.2 Adjust Screen Contrast and Brightness

**Figure 23**  
Adjusting Contrast and Brightness

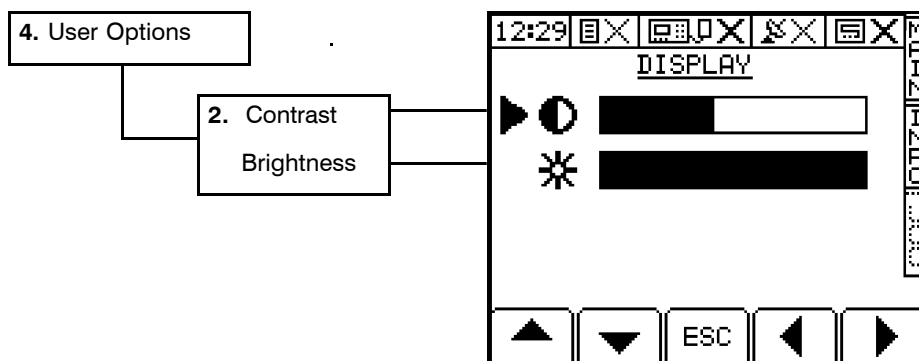

The screen may go darker at very high or very low temperatures. For example, on a very cold morning it may take a short period of time for the display to gain normal contrast as the instrument warms up. This is a normal characteristic of this type of display and does not mean the display is faulty.

If by accident the contrast setting is adjusted so that the screen graphics can no longer be viewed (i.e. completely light or dark), don't panic! - you can navigate directly to the "DISPLAY" screen by pressing and holding the  key for at least 20 seconds. The instrument will bleep at 0.5 second intervals as long as the key is depressed.

You can then adjust the display using the arrow keys.

### 6.3 Set Units

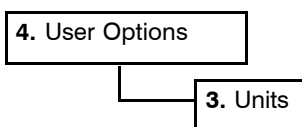

Units are either Metric (litres/hectare) or Imperial (gallons/acre).

### 6.4 Select Language

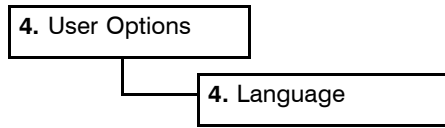

Select the language using the up / down arrow keys and press .

### 6.5 Select Control Software

**Figure 24**  
Select Control Software

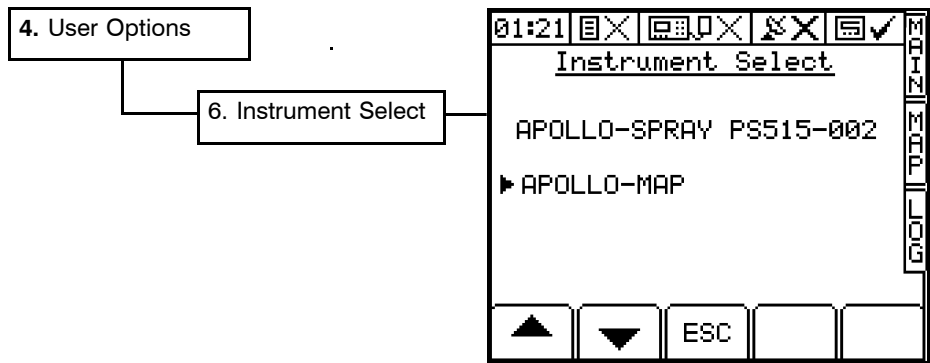

There are two lines displayed. If the head unit does not have a secondary software module fitted, both lines will be the same and switching between them has no effect.

If a software module is fitted, then simply select between the two software options displayed and press . The instrument will take several seconds to load the control software and then automatically re-start.

**NOTE:** Does not apply to the AGRIBUGGY™ instrument.

# 7 General PF Setup

The instrument must be setup to recognise the Data Module (section 4.5.1) and GPS Input (section 4.6.1).

The "GENERAL PF SETUP" menu is common to all PS8000 control software modules PS515-xxx (Sprayers), PS516-xxx (Belt Spreader), PS805-xxx (Disc Spreader) and PS517.xxx (Route / Soil Mapping), and PS302-xxx (Ceres 8000 Yield Monitor) so some settings may not apply in your current application.

For information on connecting and configuring RDS PF *hardware* e.g. the Data Card Module, Secondary Software Module, DGPS Receiver, cables etc, and data transfer to your PC, please refer to the "Precision Farming Supplement".

## 7.1 Set Logging Interval

**Figure 25**  
Select Control Software

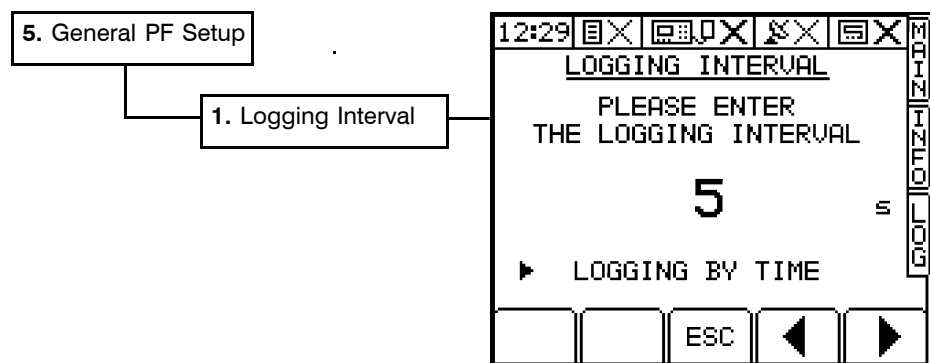

It is recommended that you use the default setting of 5 seconds. This should be adequate for variable-rate treatment and yield mapping.

Decreasing the logging interval may affect the responsiveness of the control system and generate very large log files, therefore reducing the number of jobs that can be accommodated on the PCMCIA card. An exception is when you are boundary mapping (where less data is being generated), you can reduce the logging interval to get better definition of the field boundary.

Simply enter the interval value and press  to confirm.

Although the option to select the logging interval by distance is available (using the left / right arrow keys), it no longer recommended you do so.

## 7.2 Edit Tag Names

**Figure 26**  
Edit Tag Names

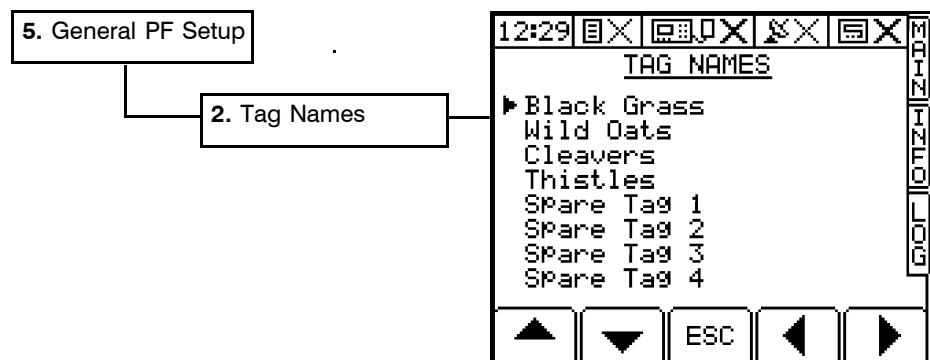

Applies to yield mapping only.

While dynamic logging is in progress the operator can switch on or off any of up to 8 'tags' which effectively place markers on subsequent yield maps to denote particular features such as weed patches etc. Each tag can be named (up to 20 characters) to denote its meaning on the yield map. The first 4 tag names are factory preset as:-

- Black Grass
- Wild Oats
- Cleavers
- Thistles

To change a name, first position the menu pointer against a 'Tag number' (fig. 26). Using the RIGHT ARROW key, move the screen cursor across to the tag name and enter the data (up to 20 alpha-numeric characters) via the alpha-numeric keypad.

Press **↵** to confirm the data entry then repeat the procedure as required for further tag names.

### 7.3 Edit Function Names and Values

**Figure 27**  
Edit default Extended Function Names and values

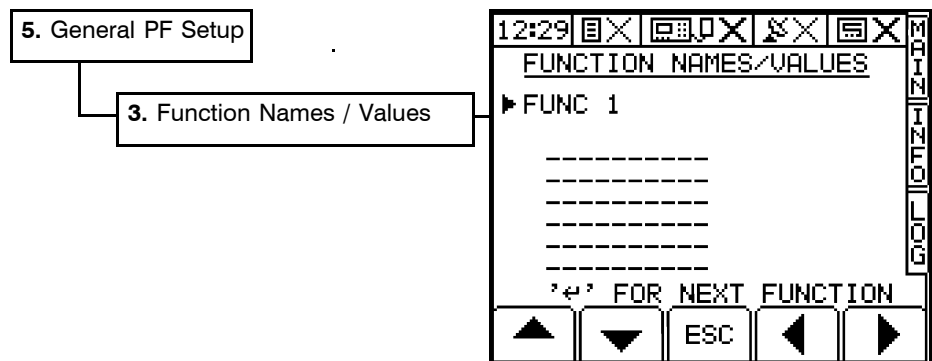

The default settings can be re-programmed for any of the extended data functions (default names = "FUNC 1" - "FUNC 12") e.g. Crop variety, Contractor information etc.

**To change a name**, first select the function number using the **↵** key (fig. 27). Using the RIGHT ARROW key, move the screen cursor across to the function name and enter the data (up to 20 alpha-numeric characters) via the alpha-numeric keypad.

**To enter a value**, move the cursor down to the first line and enter the data. You can enter up to 6 lines each of 10 characters.

### 7.4 Set GPS Antenna Offset

**Figure 28**  
Set GPS Antenna Offset

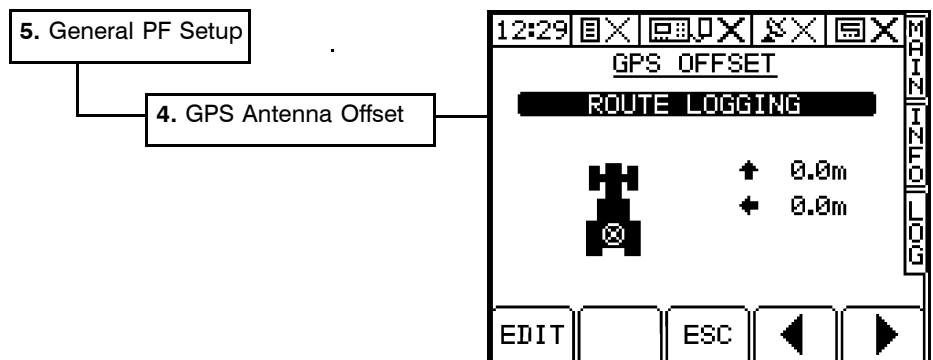

The "Antenna Offset" allows you to compensate for the difference in position between the GPS antenna and the feature being logged, centre of the spray boom/cutter bar/coulter bar, or the centre point of a spreading pattern. For example you might need a 2 metre side offset for boundary mapping from a quad bike. If you are using a front or rear-mounted sprayer/spreader (or both in some cases), you can make front / rear offsets for up to 4 "tanks".

You can have six separate configurations for,

ROUTE LOGGING  
SOIL SAMPLING  
PLAN CHANNEL 1  
PLAN CHANNEL 2  
PLAN CHANNEL 3  
PLAN CHANNEL 4

(Default for all configurations = no offset).

- 1 Select the configuration that you wish to edit and press the EDIT key (fig. 28).
- 2 Use the arrow keys to offset the antenna position in 0.5 metre increments (fig. 29).

**Figure 29**  
Offsetting the antenna position

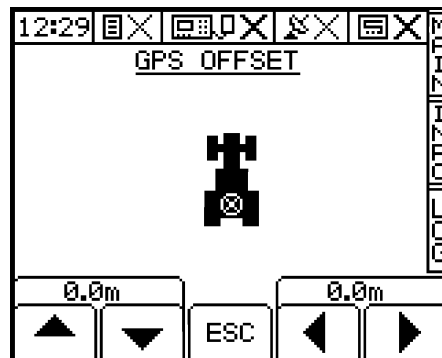

## 7.5 GPS Home Location

**Figure 30**  
Set GPS Antenna Offset

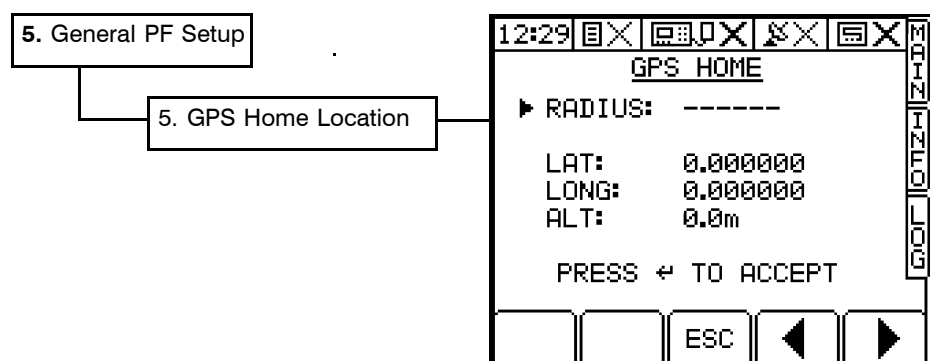

### 7.5.1 Setting the Home Location and Operating Radius

This page should display your current position from your GPS receiver. Press  to store this position as the "home location" e.g. the farm.

Enter a radius value. Any position received outside the operating radius will be ignored and is assumed to be corrupt data.

### 7.5.2 **Moving to another location**

If you subsequently move outside the radius circling the home location, the instrument will automatically reset the "home location" to the current position ONLY IF it receives 10 consecutive, full differential GPS signals.

At any time, you can press the  key to manually set the home location to your current position.

# 8

## "AGRIBUGGY CAL" ICM Menu

This menu is for calibrating the ICM functions.

This menu is not accessible to the operator and requires a special factory PIN to gain access. The following information is provided for reference only.

**Figure 31**  
The AGRIBUGGY CAL  
menu

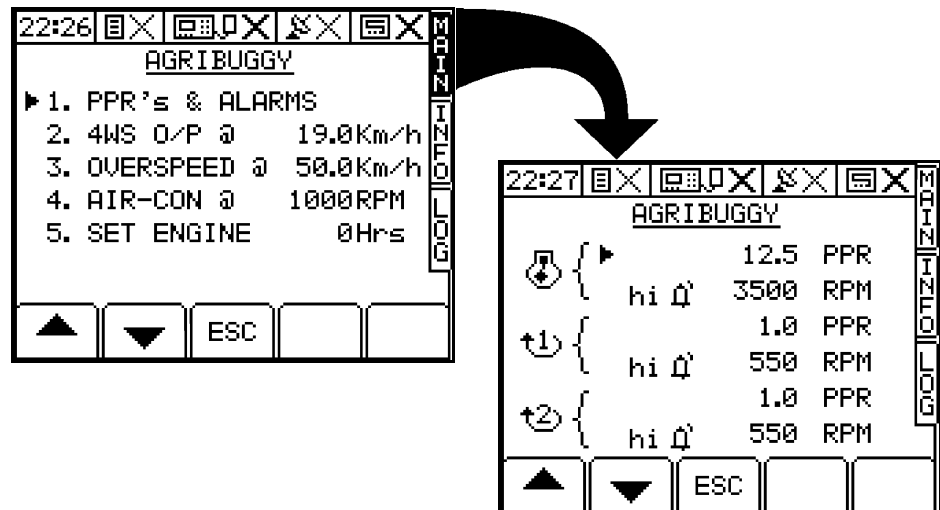

### 8.1 Engine / Shaft RPM Sensor Cal. Factor and Overspeed Alarm

The Engine RPM sensor Cal. Factor is preset to 12.5 pulses per rev (p.p.r). The engine overspeed alarm will operate if the engine speed exceeds 3500 rpm.

The standard magnetic shaft speed sensor cal. factor is always 1 p.p.r. The shaft overspeed alarm thresholds are both 550 rpm. To change any of the alarm thresholds, position the cursor using the up/down arrow keys and enter the required value using the alpha-numeric keys.

### 8.2 Engine Hours

You can also change the engine hours that have been logged. Select the line "SET ENGINE" (fig. 31) and enter the required figure.

### 8.3 Other ICM function settings

These settings should not be changed in normal circumstances.

"4WS O/P " :- Sets the forward speed limit above which 4-wheel steering is inhibited.

"OVERSPEED" : Sets the forward speed limit above which a speed-retarding system is activated.

"AIR-CON" :- Sets the engine RPM limit below which the air-conditioning system is disengaged.

*Document History*

---

Issue 1		Original Issue
Issue 2	9/8/01	Updated to Agribuggy S/W Ver. PS519-000rev.9