



IN-CAB MONITOR & SPRAYER  
CONTROLLER  
**Operation**

RDS Part.No.:  
Doc. Issue:  
Software Issue:

S/DC/500-10-231  
3b : 10/8/01  
PS519-000 rev..9

---

## Electromagnetic Compatibility (EMC)



This product complies with Council Directive 89/336/EEC when installed and used in accordance with the relevant instructions.

### IMPORTANT, READ THIS BEFORE USING THE INSTRUMENT

The installation is a part of the Precision Farming System ("the System"). It is very important that you follow the described calibration procedures before operating the instrument. Calibration and operation must be in accordance with these instructions. Use of the System is subject to the following disclaimer;

- 1. So far as is legally permissible RDS Technology ("RDS"), or its distributors, shall not be liable, whatever the cause, for any increased costs, loss of profits, business, contracts, income, or anticipate savings or for any special, indirect or inconsequential damage whatsoever (death or personal injury excluded).*
- 2. The capabilities and functions of the Precision Farming System ("the System") are limited as set out in the specification of the System, details of which are contained in the Help files and product literature and which must be read before using the System.*
- 3. Without prejudice to the generality of the above it is hereby acknowledged that the System is not designed nor intended to a) originate variable treatment plans or b) achieve or avoid any application rate outside application parameters, which in both cases shall be the responsibility of the operator.*
- 4. The standard terms and conditions of RDS (except clause 7), a copy of which is available on request, apply to the supply and operation of this System.*

## Service and Technical Support

PLEASE CONTACT:

Kellands Agricultural Spraying Supplies,  
Brimpsfield Rd.,  
Birdlip,  
Gloucester. GL4 8JH.

Tel 01452 863900

Fax 01452 863400

Our policy is one of continuous improvement and the information in this document is subject to change without notice. Check that the software reference matches that displayed by the instrument.

© Copyright RDS Technology Ltd 2001

\UK231-3b.DTP

---

# CONTENTS

## Section 1 Overview

1.1	The In-Cab Monitor (ICM) functions . . . . .	4
1.2	Sprayer Control Modes . . . . .	4
1.3	Calibration Mode . . . . .	4
1.4	The Operating screens . . . . .	5
1.4.1	Menu keys - 5	
1.4.2	The ICM FUNCTIONS screen page - 5	
1.4.3	The MAIN screen page - 6	
1.4.4	Status Indicators - 6	
1.4.5	The INFO screen page - 7	
1.4.6	The LOG screen page - 7	
1.4.7	The SETUP screen page - 8	
1.4.8	Data Entry - 8	
1.4.9	Units - 9	

## Section 2 Operation

2.1	Startup . . . . .	10
2.2	Selecting the Tank / Product . . . . .	10
2.2.1	Editing Product Names - 10	
2.3	Nozzle Settings - the "Nozzle Wizard" . . . . .	11
2.3.1	Setting the Target Speed - 12	
2.3.2	Using the Nozzle Wizard - 12	
2.3.3	Editing a Preset Nozzle Type - 12	
2.3.4	Programming the Product Density - 13	
2.4	Automatic Rate Control . . . . .	14
2.4.1	Setting the Target Rate - 14	
2.4.2	Overriding the Target rate - 14	
2.5	Manual Rate Control . . . . .	14
2.6	MAIN Screen Display Options . . . . .	15
2.7	Tank Contents . . . . .	15
2.7.1	Tank Filling (Manual) - 16	
2.7.2	Tank Filling (Automatic) - 16	
2.8	Part / Total Accumulation . . . . .	17
2.8.1	Reset Totals - 17	
2.9	Forward Speed and Flow Rate Alarm . . . . .	18
2.9.1	Spray Performance Indicator - 18	
2.9.2	Setting the Alarm Thresholds - 18	
2.10	ICM Functions . . . . .	19

## Section 3 Logging Options

3.1	Hardware Setup . . . . .	20
3.2	Variable Rate Treatment (VRT) . . . . .	21
3.2.1	Running a Variable-rate Treatment Plan - 21	
3.2.2	Overriding the VRT Application Rate - 22	
3.2.3	Stopping a VRT Job - 22	
3.2.4	Tagging - 23	
3.2.5	Extended Data Functions - 23	
3.2.6	Display Vehicle Track (MAP) - 24	
3.2.7	Display GPS Status - 24	
3.3	Dynamic data Logging . . . . .	25
3.4	Field Data Logging . . . . .	26
3.5	Review, Reset or Download a Job Summary . . . . .	27

# 1 Overview

## 1.1 The ICM (In Cab Monitor) Functions

On startup the instrument will display the first of two "MAIN" screen pages which displays the ICM functions - Forward Speed, Engine RPM, up to 2 Shaft Speed Inputs (depending on the particular installation), and Engine Hours in operation.

## 1.2 Sprayer Control Modes

The instrument has three control modes;

### Manual Control Mode

This gives simple manual control of application rate. Field data ("job memos") can be logged and stored in the instrument memory. Field data ("job summaries") can be logged and are stored in the instrument memory. Up to 75 summaries can be stored.

### Automatic Control Mode

This gives fully automatic rate control. Flow / pressure is automatically regulated as forward speed varies, to ensure that the actual application rate constantly matches a preset target rate. The application rate can be manually nudged up and down from the target rate as required for spot application in specific areas. Programmable alarms warn of high and low flow rates.

Field data ("job summaries") can be logged and are stored in the instrument memory. Up to 75 summaries can be stored. If you have a GPS receiver and RDS Data Card Module connected, as well as creating a job summary, you can also log the vehicle route and application data to a "dynamic log" file on the PCMCIA card. The job summary data is also appended to this file, which can be viewed in PLOT/PLAN.

### VRT (Variable-rate treatment) Control Mode

This enables the system to be controlled via treatment instructions prepared using RDS PLOT/PLAN or similarly capable Precision Farming software programs, in conjunction with DGPS position data. To enable fully automatic variable-rate treatment for Precision Farming applications, the instrument requires a suitable DGPS receiver and the RDS PCMCIA Card Module to implement treatment plans generated in RDS PLOT/PLAN.

A work record file is automatically created on the card module to log data confirming the actual treatment. The job summary data is also appended to this file, which can be viewed in PLOT/PLAN.

*Please refer to the 'Precision Farming Supplement' Pt No. S/DC/500-10-202 for details of DGPS installation, setup and data transfer with the Data Card Module.*

## 1.3 Calibration Mode

The instrument must be calibrated before commencing normal operation. Many settings are made only on initial installation. Other calibration settings may need to be altered according to the liquid being sprayed, nozzle types being used etc.

*Please refer to the Calibration manual supplied with your instrument.*

## 1.4 The Operating Screens

### 1.4.1 Menu keys

All instrument functions are accessed by nine menu keys adjacent to the LCD display.

**Figure 1**

The functions are controlled via the menu keys next to the display

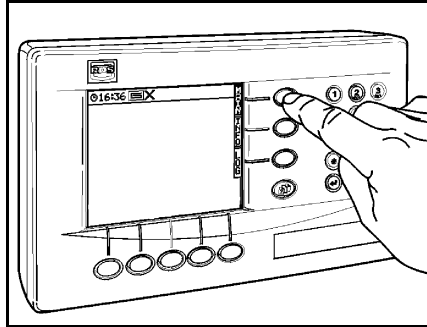

The four menu keys to the right of the screen (figure 1) access the primary screen pages (those viewed during normal operation). There are three primary screens MAIN, INFO and LOG for normal operating functions, and a SETUP screen for calibration functions.

The five sub-menu keys below the screen control the various display functions and settings for each of the primary screen pages. Text or icons are displayed adjacent to the sub-menu keys to denote their function.

### 1.4.2 The ICM FUNCTIONS screen page

The instrument will always default to the "ICM FUNCTIONS" screen on startup. The screen displays the following information (figure 2).

**Figure 2**

The information displayed on the ICM screen

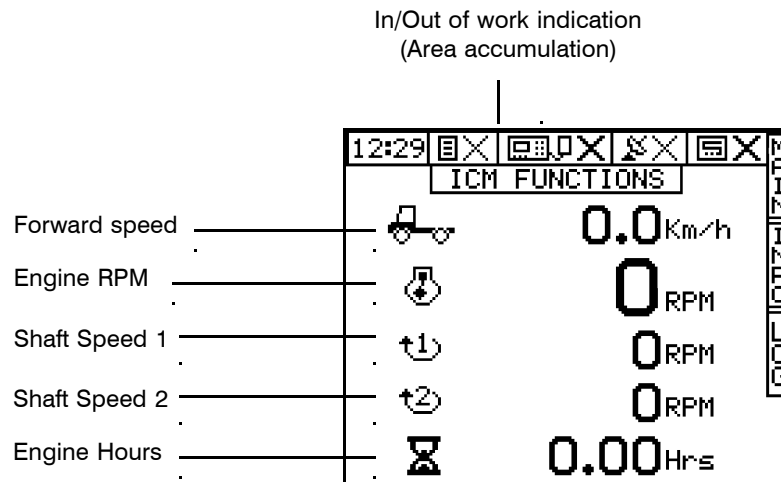

Press the "MAIN" key to toggle between the "MAIN" operating screen (sprayer functions) and the ICM screen.

### 1.4.3 The MAIN screen page

The instrument will always default to the MAIN screen on startup. The MAIN screen displays the following information (figure 3).

**Figure 3**  
The information displayed on the MAIN screen

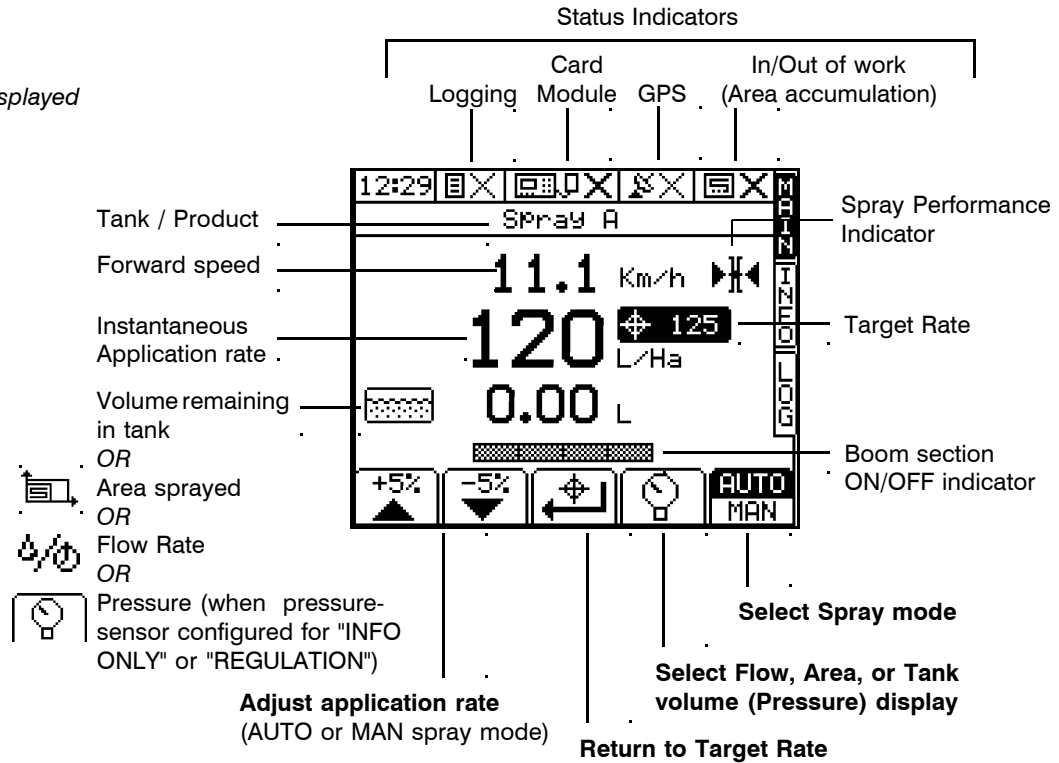

### 1.4.4 Status Indicators

The row of icons at the top of the page show the following;

(i) if logging is in progress or not :-



(ii) if the Card Module is connected and whether a card is inserted:-



(iii) if a GPS signal is being received :-



(iv) if the area / distance is being accumulated :-

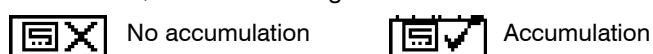

**NOTE:** The GPS icon and the Data module status icons will only appear if the GPS / Data Module settings are selected in the "PORTS SETUP" menu (refer to the calibration manual).

Otherwise, the status indicators will appear on all the screen pages

### 1.4.5 The INFO screen page

Additional work measurement functions are displayed on this page. If only one tank is enabled, the screen will display only the product selected and not the tank number as shown in figure 6.

**Figure 6**  
The INFO screen

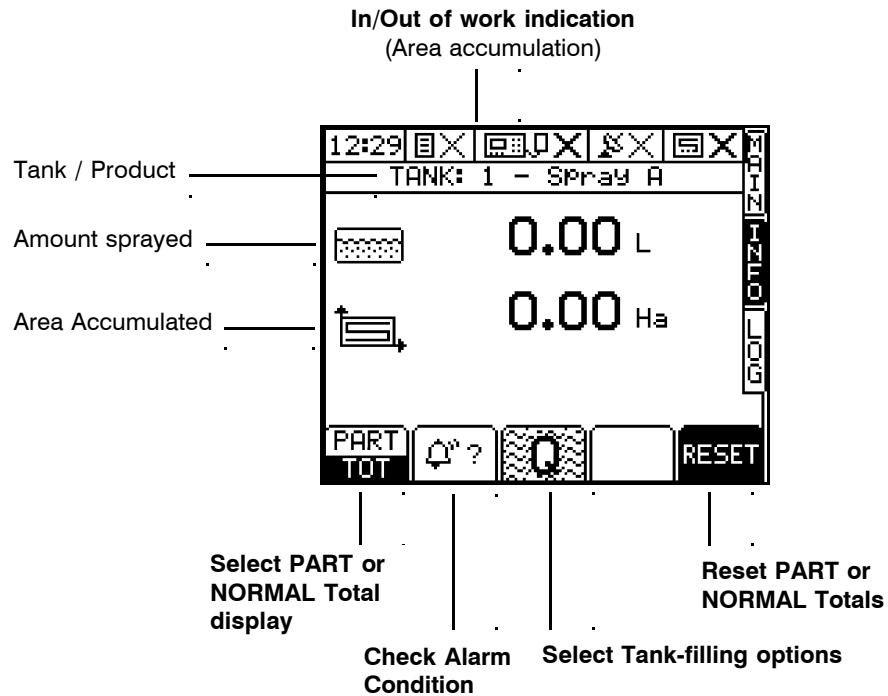

### 1.4.6 The LOG screen page

This page controls data logging (Field Summary data), and P.F. functions (when the Data Card Module is connected and enabled) and data transfer (e.g. printing a job summary).

**Figure 7**  
The LOG screen

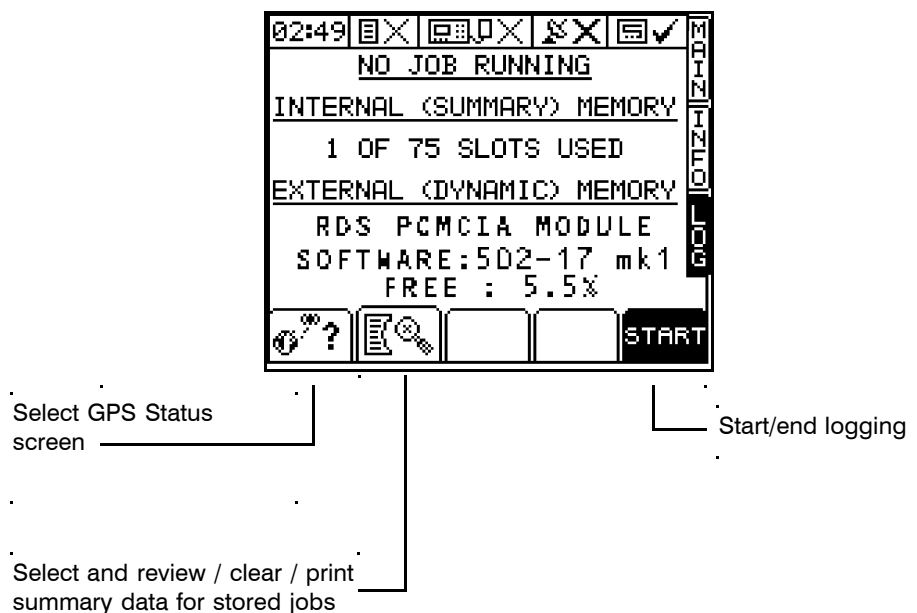

### 1.4.7 The SETUP screen page

The  key selects the SETUP menu for calibration factors and calibration settings specific to particular products being sprayed and nozzle types fitted.

**Figure 8**  
The information displayed on the SETUP screen

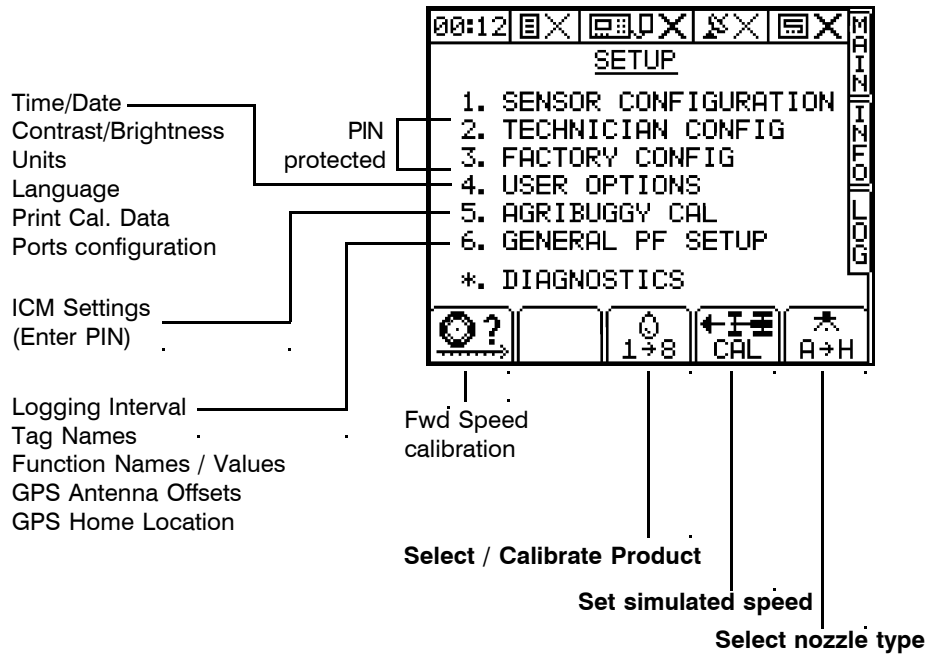



You should not need to enter menus 1, 2 and 3 and 5 in normal use. These settings are generally made only on initial installation. Menus 2,3, and 5 are protected with a personalised PIN number to prevent unauthorized access. Calibration settings that need to be changed during normal use are shown on figure 8.

### 1.4.8 Data Entry

Alpha-numeric values are entered via the right-hand keypad. You must press the key from 2 to 5 times to select the required letter. (Some keys have additional special characters not shown on the key legend).

The  key will either toggle between lower and upper case characters or when preceding a numerical entry, will set a MINUS value.

The  key will toggle between 0 and a SPACE.

The  key will BACKSPACE the screen cursor if you need to re-enter a character.

The  key is the RETURN key and is normally pressed to confirm the data entry into memory.

### 1.4.9 Units

Information can be displayed in Metric or Imperial units by selecting the desired option via the SETUP menu. Please refer to the Calibration manual.

The units are:-

Function	Units	
	Metric	U K Imperial
Forward Speed	k m/hr	miles/hr
Application rate	l itres/ha	g allons/acre
Flow rate	l itres/min	gallons/min
Part/Total Area	h ectares	a cres
Tank volume, Part/Total volume applied	l itres	g allons
Spray pressure	b ar	lbs/in <sup>2</sup>

#### Special Note:- Single Channel Control System

This manual refers to a 4-channel sprayer controller where each control channel by default is referred to as a "Tank".



The Agribuggy™ instrument is a single-channel control system, therefore please ignore any further reference in these instructions to selecting "tanks" or where the  symbol appears.

# 2 Operation

## 2.1 Startup

Press the  key. The startup screen, which shows the software version, will display for about 8 seconds then the "ICM FUNCTIONS" screen is displayed.

## 2.2 Selecting the Tank / Product

- 1 Press the  key and then press the  key (figure 9a).

The 'PRODUCT SELECTION' screen only lists tanks that have been enabled via the calibration menu.

**NOTE 1:** By default, the tank is labelled "Tank 1", however, this description may be edited via the "MACHINE OPTIONS" page in the calibration menu.

- 2 Select the tank using the left / right arrow key, then using the up / down arrow key, move the screen cursor opposite the product for that tank (figure 9b). For any tank, you can programme and calibrate up to 8 different products "A" to "H".

**NOTE 2:** By default, the products are labelled "A" for tank 1, "B" for tank 2, "C" for tank 3 and "D" for tank 4. You can edit the product description by pressing the  key while the "PRODUCT SELECTION" screen is displayed (section 2.2.1).

**Figure 9**  
Selecting the PRODUCT SELECTION screen

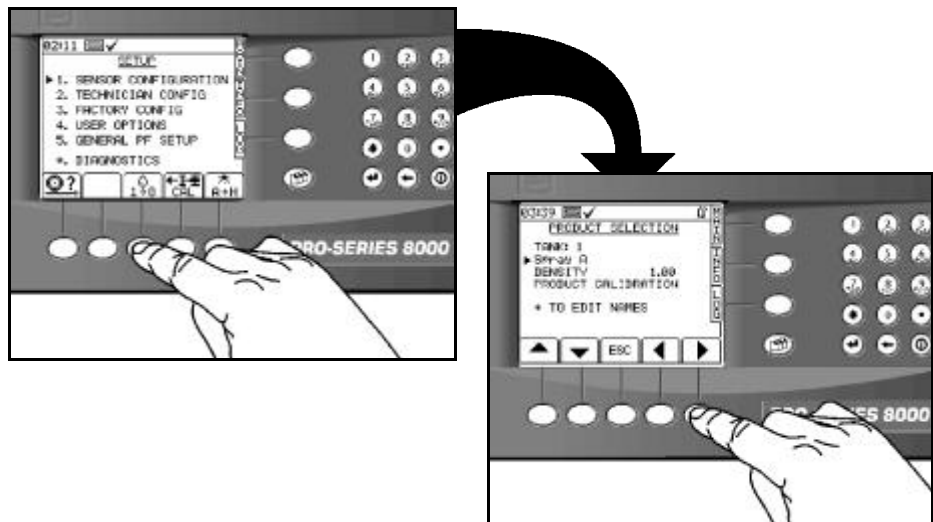

- 3 Press the MAIN key to return to the "MAIN" screen page.

### 2.2.1 Editing Product Names

The 8 default product descriptions are 'Spray A' to 'Spray H'.

From the 'PRODUCT SELECTION' screen, press the  key to select the 'PRODUCT NAMES' screen.

Select the product name using the arrow keys, and edit the name using the alphanumeric keypad.

### 2.3 Nozzle settings - the "Nozzle Wizard"

The "Nozzle Wizard" will assist you to choose the appropriate nozzles for a chosen application rate and forward speed.

**Figure 10**  
Selecting the "Nozzle Wizard"

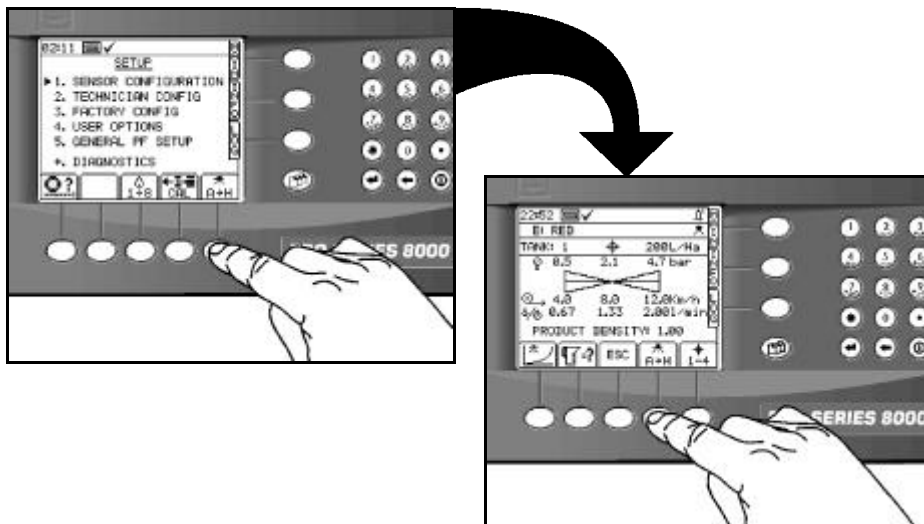

The "Nozzle Wizard" displays the following;

**Figure 11**  
The "Nozzle Wizard"

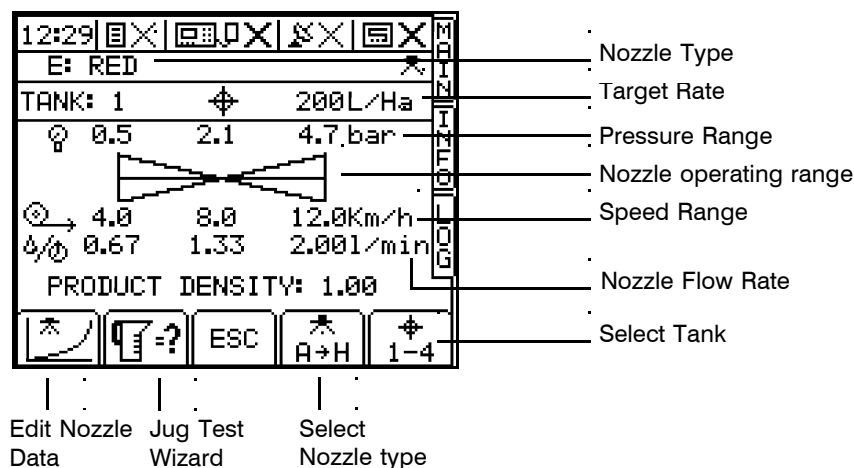

The Nozzle Wizard page shows you how a selected nozzle will perform in order to achieve the Target Application Rate at a programmed Target Speed.

The centre of the "bow tie" display indicates the target speed for optimum nozzle performance. The operating range of the nozzle is based on the target speed.

There are 8 pre-programmed, ISO standard nozzle types A to H ;

Type	Colour
A	Orange
B	Green
C	Yellow
D	Blue
E	Red
F	Brown
G	Grey
H	White



**NOTE:**



If you have more than one "tank" enabled, on selecting "Nozzle Setup", the instrument will first prompt you to select the channel to which the nozzle setup will apply (fig. 12) before displaying the "Nozzle Wizard" screen.

Alternatively you can press the  key in the Nozzle Wizard to select the tank to which the Nozzle Wizard refers.

**Figure 12**  
Selecting the "Tank" in the Nozzle Wizard





**2.3.1 Selecting the Target Speed**

- 1 From the SETUP page, press  .
- 2 Key-in the speed and press  to start the speed simulation. The display will revert to the MAIN screen and the  icon will start flashing.

Speed simulation can only be started with the sprayer stationary. To stop speed simulation, press the  key or move the vehicle a short distance.

**2.3.2 Using the Nozzle Wizard**

- 1 Set your Target Speed as above.
- 2 Key-in the target application rate either on the MAIN page or on the "Nozzle Wizard" and press  .
- 3 Cycle through the nozzles with the  key until a nozzle is reached closest to the desired spraying pressure and press  .
- 4 Fit the appropriate nozzles to the sprayer.

**2.3.3 Editing the preset Nozzle type**





If the nozzles fitted do not correspond to any of the 8 preset types, then you must select one of the nozzle types A to H and edit the calibration data according to the nozzle manufacturers data.

Press the  on the Nozzle Wizard to edit nozzle data.

### 2.3.4 Programming the Product Density

You must programme the correct density when spraying fertilisers. The system will then automatically compensate in order to maintain the correct application rate and spray performance.

Whenever the programmed density for the selected product is anything other than 1.00 the instrument will display the  icon on the main screen.

- 1 Press  to select the "SETUP" screen.
- 2 Press  to select the "PRODUCT SELECTION" screen (fig 9).
- 3 Select the "DENSITY" line, key-in the correct density and then press  .
- 4 Use the "ESC" key or press  to return to the "SETUP" screen, (or press the MAIN key to return to the operation screen).

### 2.3.5 Nozzle Calibration

Refer to section 3 of the calibration manual.

## 2.4 Automatic Rate Control



Select 'AUTO' from the 'MAIN' screen. The flow rate will be automatically adjusted as forward speed varies, to ensure that the application rate constantly matches the preset target rate.

### 2.4.1 Setting the Target Application Rate

From the "MAIN" screen simply key-in the desired target rate and press .

### 2.4.2 Overriding the Target Application Rate

Press to override the target rate.

The preset target rate can be overridden in  $\pm 5\%$  steps while spraying, e.g. over localised weed infestation or other crop conditions.

While overridden, the target rate indicator 100 will flash.

Press to return to the target rate.

**NOTE :** *The instrument will automatically alarm if the flow rate/forward speed goes above or below the limits programmed via the 'SETUP' menu.*

When the alarm threshold is reached first of all the screen will change to show the alarm screen and the message "FLOW LOW" or "FLOW HIGH" is displayed. The instrument will beep continuously. Press any of the lower 'OK' keys to cancel the alarm screen and return to the 'MAIN' operating screen. An alarm bell icon in the upper right hand corner of the screen will continue to flash and the instrument will beep every 5 seconds to remind you of the alarm condition.

**NOTE:** *If the instrument flashes the alarm bell icon as above, at any time you can re-identify the cause of the alarm by pressing the key on the INFO screen.*

## 2.5 Manual Rate Control



You do not normally need to select this mode, however in the event you experience a problem with automatic control (if for example the forward speed sensor had stopped working), you can still control the application rate manually.









Select 'MAN' from the 'MAIN' screen. To maintain the required application rate, you must maintain a constant forward speed. You can also log and store field data ("job summaries") as you go, and print them out or download them to a PC or printer when convenient.

Press to adjust the application rate.

**NOTE :** *The speed range indicator functions as normal, however there is no forward speed or flow rate alarm in manual mode.*

## 2.6 "MAIN" screen display options

In addition to the Application rate and Forward Speed display, on the appropriate MAIN screen page for each machine enabled, you can select between,

-  **Volume remaining in tank** (  litres or gallons)
-  **Accumulated area** (  hectares or acres)
-  **Flow rate** (  litres/min or gallons/minute)
-  **Pressure** (  bar or psi - only on systems fitted with a pressure sensor)

**Figure 13**  
Selecting the display option  
on the MAIN screen

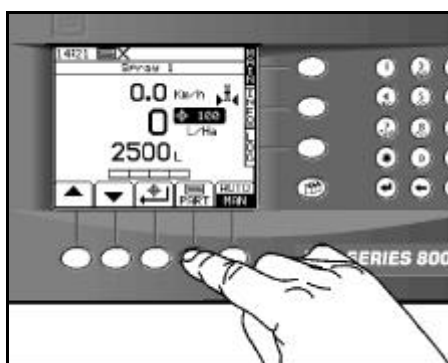

## 2.7 Tank Contents

The instrument automatically calculates the volume of liquid remaining in the appropriate tank. The calculation is based on the full tank volume which is programmed via the "INFO" screen. You can also programme an alarm threshold so that the instrument will warn you when the tank volume is getting low.

When the alarm threshold is reached (e.g. 200 litres), first of all the screen will change to show the alarm screen and the message **TANK # LOW**. The instrument will beep continuously. Press any of the lower 'OK' keys to cancel the alarm screen and return to the 'MAIN' operating screen. An alarm bell icon in the upper right hand corner of the screen will continue to flash and the instrument will beep every 5 seconds to remind you of the alarm condition.

**NOTE:** *If the instrument flashes the alarm bell icon as above, at any time you can re-identify the cause of the alarm by pressing the  key on the INFO screen.*

The screen will change to show the alarm screen and the message **TANK # EMPTY** once the tank contents register reaches zero. Again, press any of the lower 'OK' keys to cancel the alarm screen to return to the 'MAIN' operating screen, and the alarm will continue as above.

The tank contents register must be reset manually after re-filling the tank unless your system includes the optional *Tank Inflow Sensor and Flow Shutoff Valve*. When fitted this enables the instrument to automatically monitor re-filling and cut off the inflow when the tank is full.

### 2.7.1 Tank filling (Manual)

- 1 Select the "INFO" screen and press  to access the TANK FILL screen (fig. 14). The screen will display,

"MAX" - the full tank volume  
 "NOW" - the volume remaining in the tank  
 "TO ADD" - volume to replenish

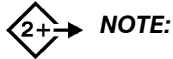

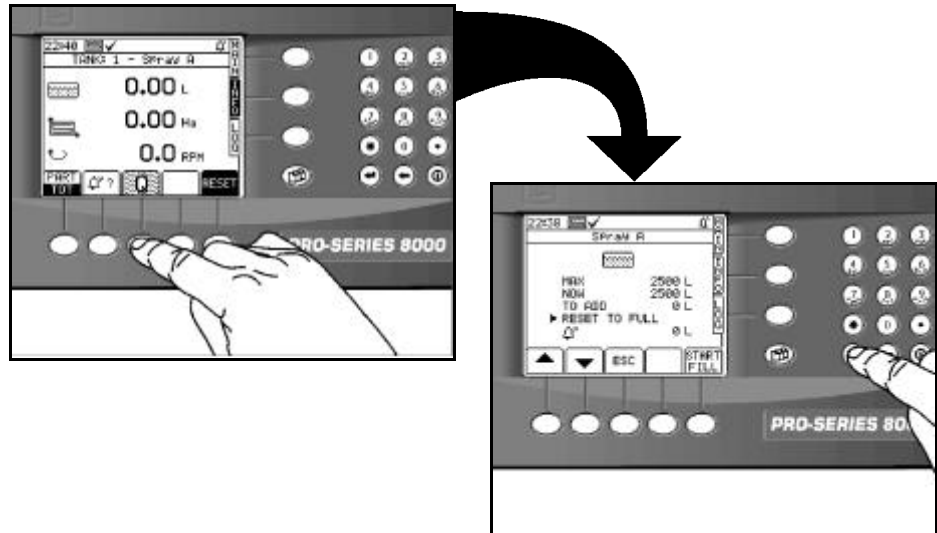

**NOTE:** If more than one tank is enabled, there is a separate screen page for each tank (as for the MAIN screen). Press the INFO menu key repeatedly to cycle between each page.

**Figure 14**  
Resetting the Tank Volume



- 2 Fill the tank to the desired level.
- 3 Confirm that "MAX" corresponds to the quantity in the tank. Adjust as necessary.

**NOTE:** Move the screen cursor using the arrow keys and enter values via the numeric keypad.

- 4 Press  to reset to the full tank volume.
- 5 Confirm the alarm volume (  ) is OK (typically the volume needed to spray a single bout). Adjust as necessary.

### 2.7.2 Tank filling (Automatic)

A Tank Inflow Sensor must be installed to measure the inflow. A Shutoff Valve must be installed to stop the filling automatically.

- 1 Connect the inflow hose.
- 2 Select the "TANK FILL" screen as above.
- 3 Confirm that "MAX" corresponds to the quantity you want in the tank after filling. Adjust as necessary.
- 4 Confirm that the "NOW" volume is the volume currently in the tank. Adjust as necessary.
- 5 Confirm the alarm volume as above.
- 6 Press the  key.
- 6

The "TO ADD" volume will then count down and the screen will display "STOP INFILL". If a Shutoff Valve is fitted, filling will cease automatically when the "TO ADD" volume reaches zero. You can also press  at any time to stop filling. An audible alarm will sound and filling will stop.

## 2.8 Part / Total Accumulation

You can record the area and volume sprayed for a particular job using the "PART" Total function. In addition the area and volume will be recorded to the "TOTAL" memory register.

- 1 Select the "INFO" screen to display the accumulated totals.



### NOTE:

*If more than one tank is enabled, there is a separate screen page for each tank (as for the MAIN screen). Press the INFO menu key repeatedly to cycle between each page.*



- 2 Select 'PART' to display the Part Area and Part Volume accumulation,



Select "TOTAL" to display the Total Area and Total Volume accumulation.

### 2.8.1 Reset Totals

- 1 Select the "PART" or "TOTAL" display.
- 2 Press the **RESET** key.
- 3 Press  to zero the totals or press **ESC** to return to the "INFO" screen.

## 2.9 Forward Speed and Flow Rate Alarm

You can preset upper and lower thresholds for forward speed and flow rate based on data from the manufacturers nozzle charts of the acceptable flow/pressure operating range. Also the system can regulate correctly only within a certain range depending on the size of the control valve and flow sensor fitted.

If these limits are exceeded then the instrument will automatically alarm. First of all the screen will change to show the alarm screen and the message '**FLOW LOW 1**' or '**FLOW HIGH 1**' (where the number is the instrument channel number). The instrument will beep continuously.

'**FLOW HIGH**' may be caused by the control valve being unable to dump sufficient flow back to the sprayer tank as a result of:- speed too slow or stationary, too small or too few nozzles in use - sections off or blocked nozzles, pump capacity too large or control valve too small.

'**FLOW LOW**' may be caused by:- forward speed too high, insufficient pump capacity, low pump speed, low or empty tank, blocked filters or incorrect jets.

Press any of the lower 'OK' keys to cancel the alarm screen and return to the 'MAIN' operating screen. An alarm bell icon in the upper right hand corner of the screen will continue to flash and the instrument will beep every 5 seconds to remind you of the alarm condition, until the forward speed and/or flow rate return within the preset limits.

### 2.9.1 Spray performance Indicator

The Spray performance Indicator shows the nozzle performance within the minimum and maximum parameters displayed on the Nozzle Wizard page. The "Target Speed" is at the middle of the speed range.

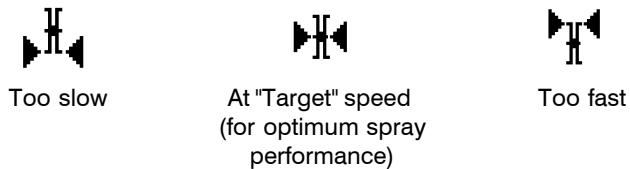

For optimum nozzle performance and spray pattern you should maintain your forward speed as close to the "target" speed as possible.

### 2.9.2 Setting the Alarm thresholds

- 1 Press  to select the "SETUP" menu.
- 2 Select the "ALARMS SETUP" screen (fig.15).

**Figure 15**  
Selecting the ALARMS SETUP screen

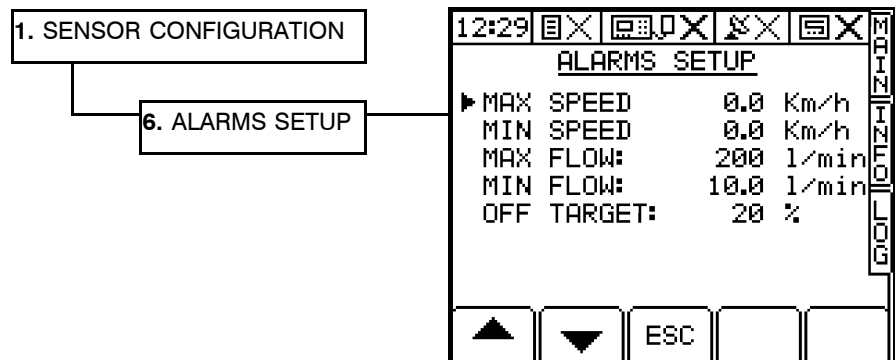

- 3 Select the appropriate alarm threshold using the arrow keys and enter the value via the numeric keypad.

## **2.10 ICM Functions**

### **2.10.1 Engine Hours Accumulation**

Engine Hours Accumulation is only resettable from the calibration menu.

### **2.10.2 ICM Alarms**

#### ***Overspeed Alarms***

There are 4 over-speed alarms for Forward Speed, Engine RPM, Shaft Speed 1 and Shaft Speed 2. These alarms must not be ignored since they are critical for the correct operation of the machine.

When any of the preset alarm thresholds are exceeded the instrument will sound an audible alarm, and the screen will display flashing arrows and warning triangles at each corner once per second.

#### ***Forward Speed inhibition***

If the forward speed exceeds the preset alarm threshold by more than 2 km/hr, the instrument will trigger a drop in engine power to counteract further overspeed. At the same time the audible and visual alarm on the instrument will increase to twice per second.

#### ***4-wheel Steer inhibition***

For safety reasons, the instrument will automatically disengage 4-wheel steering if the vehicle exceeds a preset forward speed threshold.

#### ***Air-conditioner inhibition***

To prevent the engine labouring unduly or even stalling when idling, the instrument will automatically switch off the air-conditioner when the engine speed drops below a preset limit (1000 rpm),

The alarm thresholds are programmed from the "Agribuggy CAL" section of the calibration menu.

## 3 Logging Options

The instrument has a separate LOG screen. Data is logged to internal (summary) memory and/or external (dynamic) memory (fig. 16) depending on the logging option. You can choose from three logging options. They are;

(i) **APPLY FROM PLAN (Variable-Rate Treatment)**

A variable-rate (or fixed-rate) treatment plan is imported from the RDS Data Card Module, allowing the operator to commence a full VRT application. A full spray application record of the *actual* application is generated and saved on the Data Module. The associated work record file can be viewed in PLOT/PLAN. Job summary data (iii) is also appended to the work record file.

(ii) **LOG TREATMENT (Dynamic Data Logging)**

A full spray application record is generated, logging rate and other parameters (e.g. "tags") in real time, attributing this data to a specific location. The associated "Dynamic Logging" file is viewed in PLOT/PLAN. A large amount of data is generated by dynamic logging and therefore must be saved onto an RDS Data Card Module. Job summary data (iii) is also appended to the dynamic logging file.

(iii) **LOG SUMMARY ONLY (Field Data Logging)**

For farm record keeping and traceability purposes, you can record a summary of each job or work session in the internal memory, and subsequently download directly to a PC, or print to an RDS ICP200 In-Cab Printer. The amount of summary data for each job is small, and it is saved in the internal memory. The instrument can store up to 75 individual job summaries. Options (i) and (ii) also require a GPS receiver to be connected.

**Figure 16**  
The LOG page

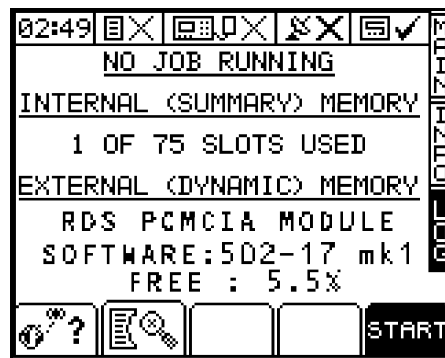

### 3.1 Hardware Setup

Connect the PCMCIA Card Module to the upper serial port on the rear of the instrument, and connect the DGPS receiver to the bottom port. The instrument must be configured to recognise the Data Module and GPS input. Make these settings from PORTS SETUP either in the TECHNICIAN menu or GENERAL PF SETUP menu. For information on connecting and configuring the Secondary Software Module, DGPS Receiver, cables etc, and data transfer to your PC, please refer to the "Precision Farming Supplement".



**NOTE:**

**Mark I Data Modules:** If you have a Mark I Data Module, always power it off before inserting or removing a PCMCIA card, otherwise you risk corrupting data stored on the card.

**Mark II Data Modules:** Mark II modules are only powered up when a PCMCIA card is inserted. If there is no card in the module when it is connected to the instrument, the module will not be detected. The PCMCIA card can be inserted or removed without any risk of corrupting stored data. The module type, software, and free space is identified on the LOG screen when the module is detected.

## 3.2 Variable Rate Treatment (VRT)

An RDS Data Card Module and a GPS receiver must be connected.

### 3.2.1 Running a Variable Rate Treatment plan

- 1 Press the LOG key.



The screen will display the current logging status, the number of jobs (job summaries) stored in memory, and the status of the PCMCIA card if found (fig. 17). If the module is not detected the message "NO MODULE FOUND" is displayed. When successfully connected, the  icon appears at the top of the screen.

- 2 Press the START key. The JOB STARTUP page is displayed.

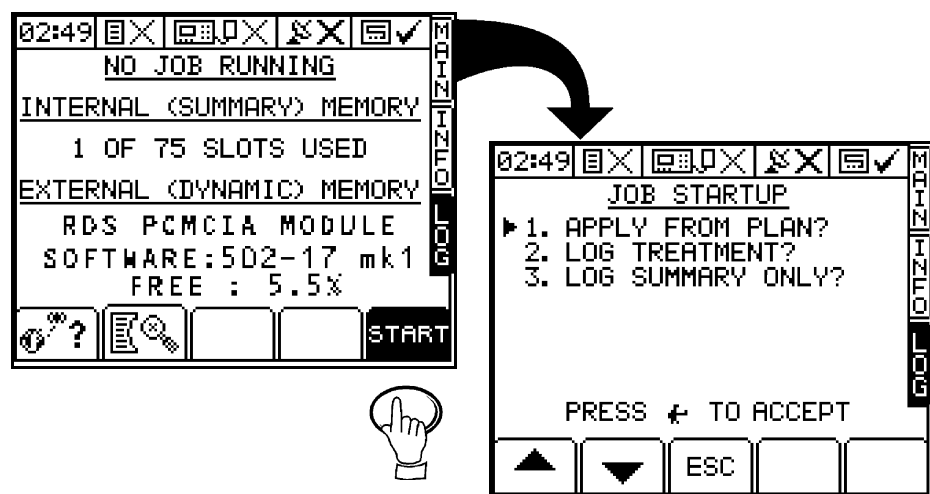

**Figure 17**  
Select the JOB STARTUP page



- 3 Select the logging option "APPLY FROM PLAN".
- 4 If known, key in the FARM NUMBER and FIELD NUMBER of the treatment plan. If not, then press the LIST key, and the display will list all the farm/fields for which there are plan files on the data card. Simply select the appropriate farm/field description in turn from the lists.

 **NOTE:** If a treatment plan is to be loaded and there is more than one "machine" (i.e. distribution system) enabled, the "SELECT MACHINE" page is now displayed. Scroll the cursor to the correct machine and press  to confirm.

- 5 SELECT THE APPROPRIATE PLAN and press .

 **NOTE:** If there is more than one "machine" enabled, the display will revert to the "SELECT MACHINE" page. If required, select another "machine", press , and then select a plan as in step 4 and 5 above.

- 6 Press the START key. The "EXTENDED DATA FUNCTIONS" page is displayed. If you don't wish to programme any extended functions, then press .

**NOTE:** If you want to programme extended functions, refer to section 3.2.5.

Wait while the work plan file is loaded and a work record file is created on the Data Module. Once the plan is loaded, the "RUNNING A PLANNED JOB" page appears, and displays the tag list (fig. 18). See section 3.2.4 about tagging.

**Figure 18**  
Running a Treatment Plan



While VRT mode is in operation a flashing satellite symbol (fig. 19) is displayed alongside the Target Rate on the MAIN screen. The  icon appears animated at the top of the screen while logging is in progress.

**Figure 19**  
Indicating that variable-rate treatment is in progress

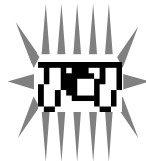

The target rate on the MAIN screen now becomes the application rate according to the treatment plan data (Base rate x Multiplier) and the position in the field. The treatment rectangle size is defined in PLOT/PLAN.



**Plan Status Display**

Press the  key to display the current application rate according to the treatment plan, for each distribution system in operation. This is displayed as "Base Rate x Multiplier = App. Rate"

**Application Rate without a GPS Signal**



If you lose the DGPS signal the treatment rate will revert to the "Base Rate" specified in the plan.

**Application Rate Outside the Field Boundary**

If you go outside the field boundary but are still within the treatment rectangle, a  icon flashes on the display and the instrument beeps continuously. The application rate reverts to the base rate.

If you are outside the field boundary and treatment rectangle, then the application rate goes to zero.

**3.2.2 Overriding the VRT application rate**

You can vary the actual application rate at any time using the   keys.



The target rate display will flash until you press  to return to the target rate.

**3.2.3 Stop a VRT job**

To stop running a job, simply press the "STOP" key on the LOG screen. The job summary is appended to the work record file on the data module, and saved to the internal memory.

### 3.2.4 Tagging

During application, you can log the presence of up to eight different features in the field, e.g. different weed infestations, pest damage etc. To switch a tag on or off, simply press the appropriate number key.

-  indicates a tag is off
-  indicates a tag is on

**Figure 20**  
Setting Tags



Tags 1 to 4 are preset for Blackgrass, Wild Oats, Cleavers and Thistles. You can however, edit the tag names from the "GENERAL PF SETUP" page.

### 3.2.5 Extended Data Functions

Dynamic log files and simple job summaries can include up to 12 additional data. All 12 data items can be user-defined to suit individual requirements e.g. Operator name, Wind Speed, Air Temperature, Growth Stage, Product etc.

Entering extended data is optional.

**Figure 21**  
Setting Extended Functions



The functions are "F1" to "F12" by default. You can re-programme the default function names and function values from the SETUP menu (please refer to the calibration manual). If you do not want to change the default, simply press  to accept it, and then the next "F" function appears (fig. 21).

Enter the data (up to 20 alpha-numeric characters) via the alpha-numeric keypad. The existing data will be over-typed. Press  to confirm the data entry.

You can repeat the data entry procedure for up to 12 'F' functions, however, if you do not need to programme any of them, simply press  at any time to start logging.

**3.2.6 Display vehicle track - "MAP"**

From the LOG screen (fig. 20), press the "MAP" key.

The screen displays the real time position of the vehicle (the "+" cursor), and the vehicle track for the last 100 logged data points.

The screen also displays the latitude and longitude in decimal degrees, and the number of points. As the vehicle proceeds from the start of the job, the screen plots and automatically zooms out to display up to a maximum of 100 logged data points. Beyond this, as the job progresses, the display pans in the direction of movement to keep the previous 100 data points on screen.

Press the 'RESET' key to start the plot again from the current position.

**Figure 22**  
Displaying the vehicle track



If you selected the "LOG TREATMENT" option from the LOG screen page, the track data is saved to a dynamic logging file on the data module, which can then be viewed in PLOT/PLAN.

**3.2.7 Display GPS Status**

From either the LOG page, "RUNNING TREATMENT PLAN" page or "RECORDING A DYNAMIC JOB" page, press the  key to view the current GPS status.

**Figure 23**  
GPS Status

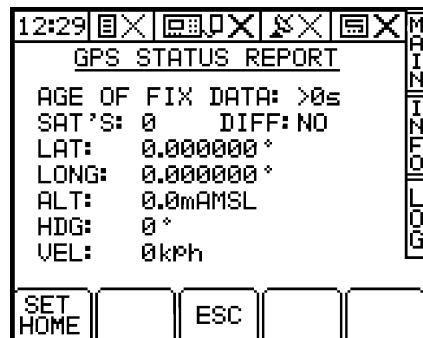

This page displays;

Age of Fix Data (when reception is good, the time should not be more than 1 second); Number of Satellites (minimum of 4 for full differential fix); Differential Status; Latitude and Longitude (in decimal degrees); Altitude; Heading and Velocity.

All this data is read directly from the NMEA GGA and VTG messages. You can also set the "Home Position" from this screen (for a full explanation of "Home Position", please refer to the calibration manual).

### 3.3 Dynamic Data Logging

When spraying conventionally (i.e. not VRT mode), you have an option to generate a full spray application record, logging rate and other parameters (e.g. "tags") in real time, attributing this data to a specific location. The associated "Dynamic Logging" file is saved onto the Data Card Module and can subsequently be viewed in PLOT/PLAN.

An RDS Data Card Module and a GPS receiver must be connected.

#### 3.3.1 Start recording a Dynamic Job

- 1 Press the LOG key.

The screen will display the current logging status, the number of jobs (job summaries) stored in memory, and the status of the PCMCIA card if found (fig. 17). If the module is not detected the message "NO MODULE FOUND" is displayed. When successfully connected, the  icon appears at the top of the screen.

- 2 Press the START key. The JOB STARTUP page is displayed (fig.17)
- 3 Select the logging option "LOG TREATMENT".
- 4 When prompted, enter the FARM NUMBER and FIELD NUMBER reference. The "EXTENDED DATA FUNCTIONS" page is then displayed. If you don't wish to programme any extended functions. then press .
- 5 If you want to programme extended functions, refer to section 3.2.5.

The screen will display "NEGOTIATING FILE STORAGE - JOB NUMBER #" as it creates the dynamic log file on the data module. Once the plan is loaded, the "RECORDING A DYNAMIC JOB" page appears, and displays the tag list (fig. 24).

**Figure 24**  
Dynamic Logging



While dynamic logging is in progress, the  icon appears animated at the top of the screen.

- 6 You can at any time apply the Tag functions to log features in the field. Please refer to section 3.2.4 overleaf.



**NOTE:**

*If more than one machine is enabled, the summary job record will include data for each machine.*

#### 3.3.2 Stop recording a Dynamic Job

To stop running a job, simply press the "STOP" key on the LOG screen. The job summary is appended to the dynamic log file on the data module, and saved to the internal memory.

### 3.4 Field Data Logging

For farm record keeping and traceability purposes, you can record a summary of each job or work session in the internal memory, and subsequently download directly to a PC, or print to an RDS ICP200 In-Cab Printer. You can store up to 75 job summaries.

#### 3.4.1 Start recording Field Data

- 1 Press the LOG key.

The screen will display the current logging status, the number of jobs (job summaries) stored in memory, and the status of the PCMCIA card if found (fig. 10a).

- 2 Press the START key. The JOB STARTUP page is displayed (fig.17)

- 3 Select the logging option "LOG SUMMARY ONLY".

- 4 When prompted, enter the FARM NUMBER and FIELD NUMBER reference. The "EXTENDED DATA FUNCTIONS" page is then displayed. If you don't wish to programme any extended functions, then press  .

- 5 If you want to programme extended functions, refer to section 3.2.5.

The "RECORDING A JOB SUMMARY" page appears (fig. 25). While field data logging is in progress, the  icon appears animated at the top of the screen.

**Figure 25**  
Field Data Logging



**NOTE:** *If more than one machine is enabled, the summary job record will include data for each machine.*

#### 3.4.2 Stop recording Field Data

To stop running a job, simply press the "STOP" key on the LOG screen. The job summary is saved to the internal memory.

### 3.5 Review, Reset or Download a Job Summary

You can view, delete, print or download the job summaries. The summary prints out as a job ticket and includes space for comments and signature. It includes all the basic data listed in section 3.5.2 along with any extended data that was programmed, for each tank that is enabled.

#### 3.5.1 Review / Reset Job Summaries

- 1 Press the  key from the LOG page.

**Figure 26**  
Review / Reset Job Summaries

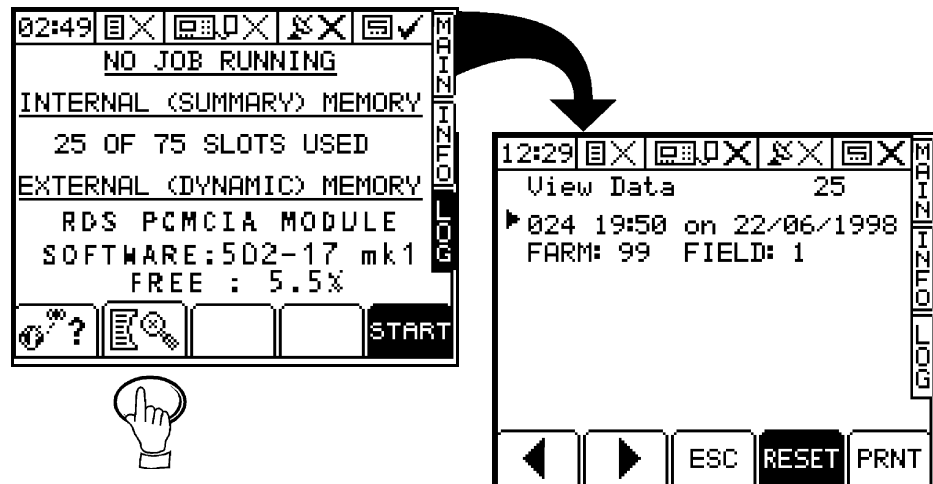

- 2 Scroll through the individual summaries using the arrow keys.
- 3 Press the **RESET** key to delete the selected summary.

#### 3.5.2 Summary Data Formats

You can download the data to;

*Data Card Module* - Each summary is saved as a text file e.g. "JOB0001.TXT", and is formatted the same as a printed job ticket.

*ICP 100 or ICP 200 In-Cab Printer* - prints in .TXT format as a job ticket with space for written comments and a signature.

*Directly onto a PC* - via the "Pro-Series PC Upload Lead" ref: RDS Pt. No. S/CB/268-1-032. Data can be output in .CSV format for import into a spreadsheet or database.

The top port should be configured as follows;

Data Card Module - "RDS PF MODULE"

ICP 100 In-Cab Printer - "RDS PRINTER TYPE I"

ICP 200 In-Cab Printer - "RDS PRINTER TYPE II"

Directly onto a PC - "PC DOWNLOAD"

Job summaries from the sprayer controller contain the following data;

- Job Number
- Start Date
- Start Time
- End Time
- Job Duration
- Channel No.
- Machine ID / Name
- Farm No.
- Field No.
- Product / Crop
- Cal Factor
- Area
- Work Rate
- Quantity spread
- Quantity loaded
- Average Application Rate
- Extended Functions F1 to F12 values

- Comments\*
- Operator\*
- Transmit Time and Date

\* Not included in .CSV format

### 3.5.3 Select and Print / Download Job Summaries

- 1 From the "View Data" page (fig. 26, 27), press the **PRNT** key.

**Figure 27**  
Download Job Summaries

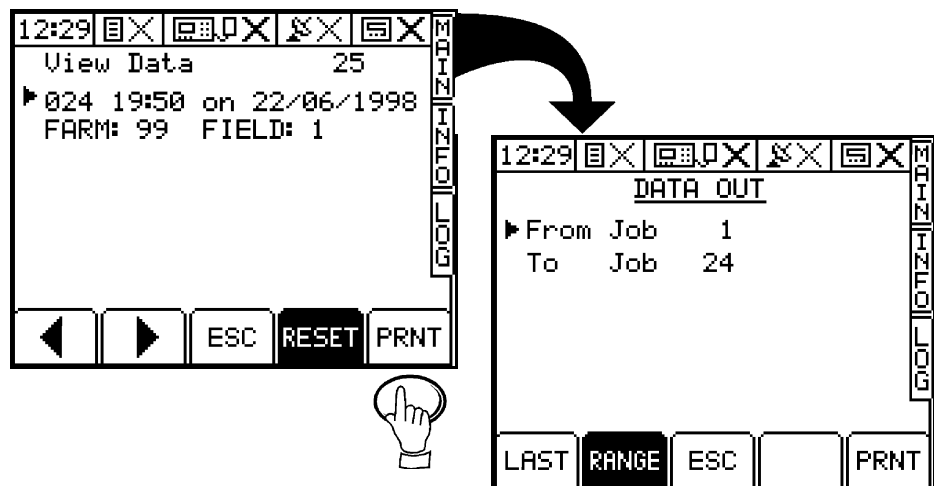

- 2 Press **LAST** to select the last summary recorded or press **RANGE** to select a number of individual summaries.
- 3 If downloading a range of job summaries, simply type the job numbers on the "DATA OUT" page, then press **PRNT**.
- 4 Select the printout style:- TEXT MODE for ASCII text output, or CSV MODE for import into an Excel™ spreadsheet.

Issue 1 : 3/10/99	Original issue
Issue 2 : 7/12/99	Update to S/W ver. 006
Issue 3 : 1/8/01	U pdated to Agribuggy S/W Ver. PS519-000rev9
Issue 3b: 10/8/01	PF routine ver. 25 :- Corrections ref. pages 7,10,20,21,22,23,25,27,28